

SONY

STEREO VIDEO CASSETTE RECORDER ^{Beta} **B**

SL-HF400

OPERATING INSTRUCTIONS

Before operating the unit, please read this manual thoroughly, and retain it for future reference.

OWNER'S RECORD

The model and serial numbers of your set are located at the rear. Record the serial number in the space provided below. Refer to these numbers whenever you call upon your Sony dealer regarding this product.

Model No. SL-HF400 Serial No. _____

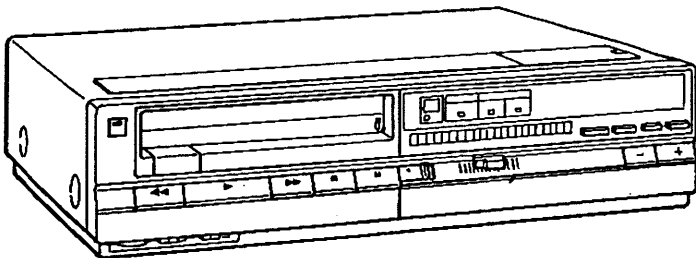

Super Beta hi-fi

This unit can be used with any video cassette tapes having the mark **B**. It is compatible with the **BII** and **BIII** type recording and playback formats, and will play back tapes recorded in the **BI** format.

TABLE OF CONTENTS

Warning 2
 Precautions 3

CONNECTIONS

Antenna/cable and TV connection 4
 Connection to an audio system 7
 Power connection 8

ADJUSTMENT

Adjusting the TV 9
 Presetting the active channels in your area 10
 Setting the clock 11

BASIC OPERATIONS

TV program recording 12
 Playback 14
 Timer-activated recording 17
 Quick timer recording 19

ADVANCED OPERATIONS

Beta hi-fi audio recording 20
 Camera recording 21
 PCM recording and playback 21
 Remote control operation 22
 Editing a tape 23

GENERAL

Location and function of controls 25
 Specifications 28
 Trouble checks 29

TIMER SETTING GUIDE back cover

INFORMATION

This equipment generates and uses radio frequency energy and if not installed and used properly, that is, in strict accordance with the manufacturer's instructions, may cause interference to radio and television reception. It has been type tested and found to comply with the limits for a Class B computing device in accordance with the specifications in Subpart J of Part 15 of FCC Rules, which are designed to provide reasonable protection against such interference in a residential installation. However, there is no guarantee that interference will not occur in a particular installation. If this equipment does cause interference to radio or television reception, which can be determined by turning the equipment off and on, the user is encouraged to try to correct the interference by one or more of the following measures:

- reorient the receiving antenna
- relocate this equipment with respect to the receiver
- move this equipment away from the receiver
- plug this equipment into a different outlet so that equipment and receiver are on different branch circuits.

If necessary, the user should consult the dealer or an experienced radio/television technician for additional suggestions. The user may find the following booklet prepared by the Federal Communications Commission helpful:

"How to Identify and Resolve Radio-TV Interference Problems". This booklet is available from the U.S. Government Printing Office, Washington DC, 20402, Stock No. 004-000-00345-4.

WARNING

To prevent fire or shock hazard, do not expose the unit to rain or moisture.

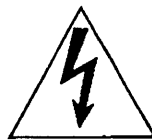
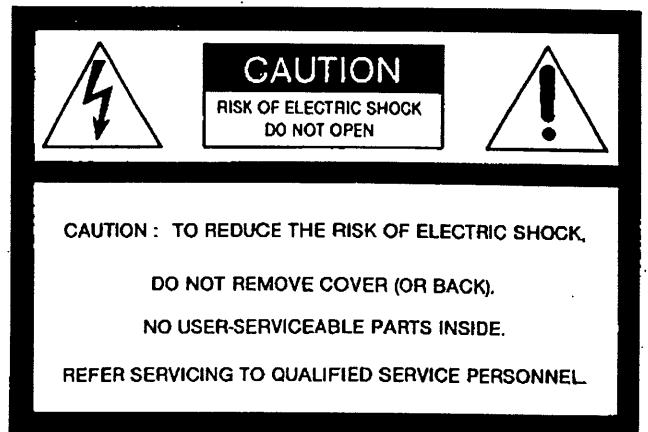

This symbol is intended to alert the user to the presence of uninsulated "dangerous voltage" within the product's enclosure that may be of sufficient magnitude to constitute a risk of electric shock to persons.



This symbol is intended to alert the user to the presence of important operating and maintenance (servicing) instructions in the literature accompanying the appliance.

CAUTION:
 TO PREVENT ELECTRIC SHOCK, DO NOT USE THIS POLARIZED AC PLUG WITH AN EXTENSION CORD, RECEPTACLE OR OTHER OUTLET UNLESS THE BLADES CAN BE FULLY INSERTED TO PREVENT BLADE EXPOSURE.

PRECAUTIONS

On safety

- Before operating, check that the operating power voltage and frequency of the unit are identical with those of your local power supply.
- Should any solid object or liquid fall into the cabinet, unplug the unit and have it checked by qualified personnel before operating it any further.
- One blade of the plug is wider than the other for the purpose of safety and will fit into the power outlet only one way. If you are unable to insert the plug fully into the outlet, contact your dealer.
- Unplug the unit from the wall outlet if it is not to be used for an extended period of time. To disconnect the cord, pull it out by the plug. Never pull the cord itself.

On installation

- Allow adequate air circulation to prevent internal heat build-up.
- Do not place the unit on surfaces (rugs, blankets, etc.) or near materials (curtains, draperies) that may block the ventilation slots.
- Do not install the unit near heat sources such as radiators or air ducts or in a place subject to direct sunlight, excessive dust, mechanical vibration or shock.
- The unit is designed for operation in a horizontal position. Do not install it in an inclined position.
- Keep the unit and cassette tapes away from equipment with strong magnets, as for example a microwave oven or a large loudspeaker.
- Do not place any heavy object on the unit.

On operation

- When the unit is not in use, turn the power off to conserve energy and to extend its useful life.
- Remove and store video cassettes after recording or playback.
- Store the cassettes in their cases and keep them in an upright position to prevent intrusion of dust and uneven winding.

On cleaning

Clean the cabinet, panel and controls with a dry soft cloth, or a soft cloth lightly moistened with a mild detergent solution.

Do not use any type of solvent, such as alcohol or benzene which might damage the finish.

On repacking

Do not throw away the carton and packing materials. They make an ideal container in which to transport the unit. When shipping the unit to another location, repack it as illustrated on the carton.

WHAT IS BETA HI-FI RECORDING?

In conventional recording, audio signals are recorded on the audio track and video signals on the video track. In Beta hi-fi recording, audio signals are recorded on the video track together with the video signals using 2 rotary video heads.

The Beta hi-fi audio signals are frequency-modulated and recorded on 2 channels, so that you can record a multichannel stereo program with sound quality far superior to that of the conventional audio recording.

Beta hi-fi recording pattern on the video tape

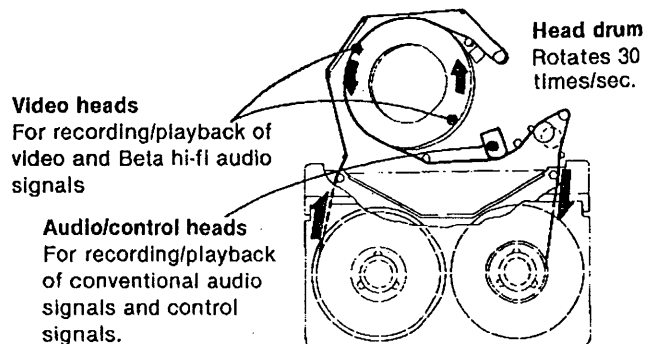
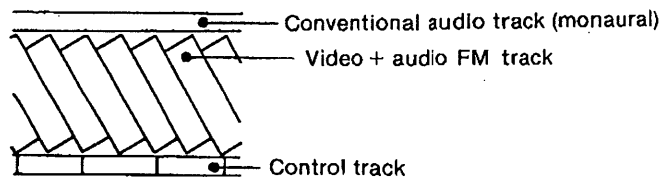

When the BETA HI-FI selector is set to ON, this recorder records audio signals on the video track (Beta hi-fi recording) and on the conventional audio track at the same time, so that these tapes can also be played back on any ordinary video cassette recorder without a Beta hi-fi system.

UHF antenna

Attach an optional EAC-66 U/V band separator to the VHF/UHF OUT connector of the recorder, and connect to the VHF and UHF antenna terminals of the TV.

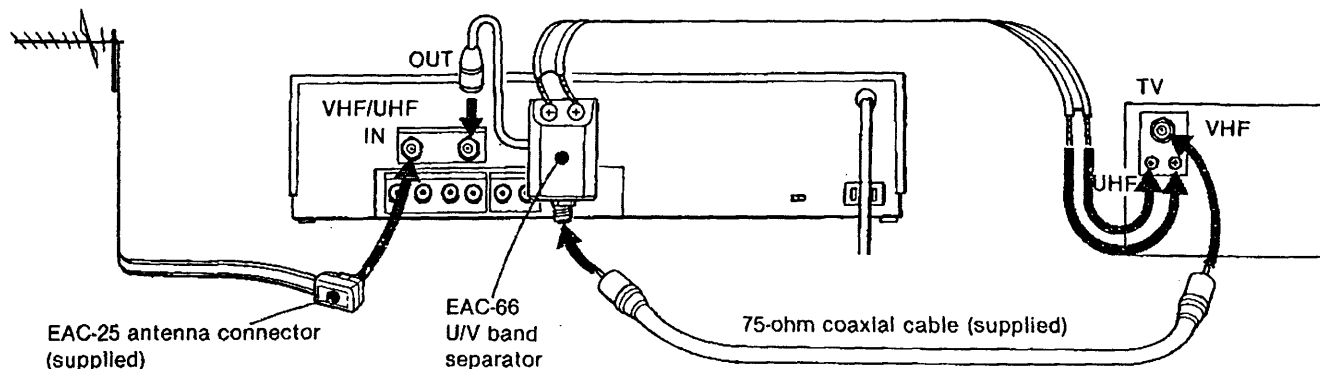

When both VHF and UHF antennas are connected

Attach an optional EAC-66 U/V band separator (mixer) to the VHF/UHF IN connector of the recorder, and connect the antennas to the U/V band separator.

Then attach another optional U/V band separator to the VHF/UHF OUT connector of the recorder, and connect to the VHF and UHF antenna terminals of the TV.

When a TV has a 75-ohm UHF/VHF antenna terminal Easy connection of the recorder to the TV can be made with a supplied 75-ohm coaxial cable regardless of the types of antenna.

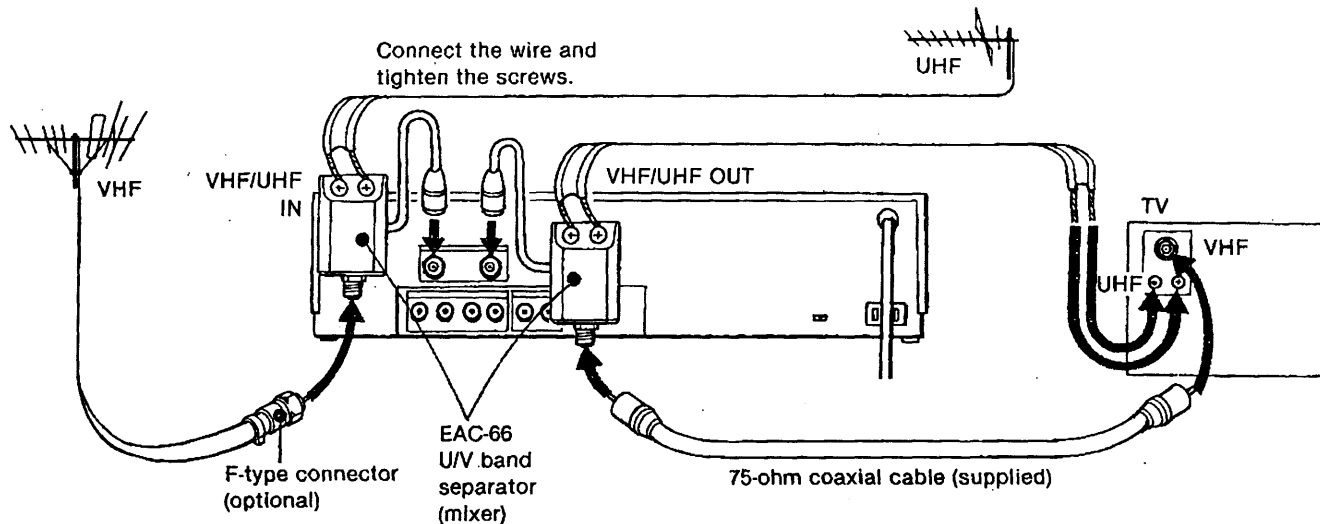

Caution

Connections between the recorder VHF/UHF OUT connector and the antenna terminals of a TV receiver should be made only as shown in these instructions. Failure to do so may result in operation that violates the regulations of the Federal Communications Commission regarding the use and operation of rf devices.

Never connect the output of the recorder to an antenna or make simultaneous (parallel) antenna and recorder connections at the antenna terminals of your receiver.

Once the connections explained above have been made, the antenna TV signals, as well as the signal from the recorder, will be fed to the TV and you can view TV programs in the usual way.

Note

Keep the VCR away from the TV, If the display or sound is affected.

CONNECTIONS

Before making connections

- Turn off the TV.
- Connect the ac power cord after all the connections of the video cassette recorder and the TV have been completed.
- Make connections firmly. A loose connection may cause a distorted picture.

ANTENNA/CABLE AND TV CONNECTION

Disconnect the TV antenna cables from the TV receiver and connect them to the recorder, then connect the recorder and the TV.

Combination VHF/UHF antenna

Most combination antennas are equipped with a U/V band separator (signal splitter). Take off the separator and connect the cable directly to the recorder.

Use the removed separator to connect the recorder and the TV.

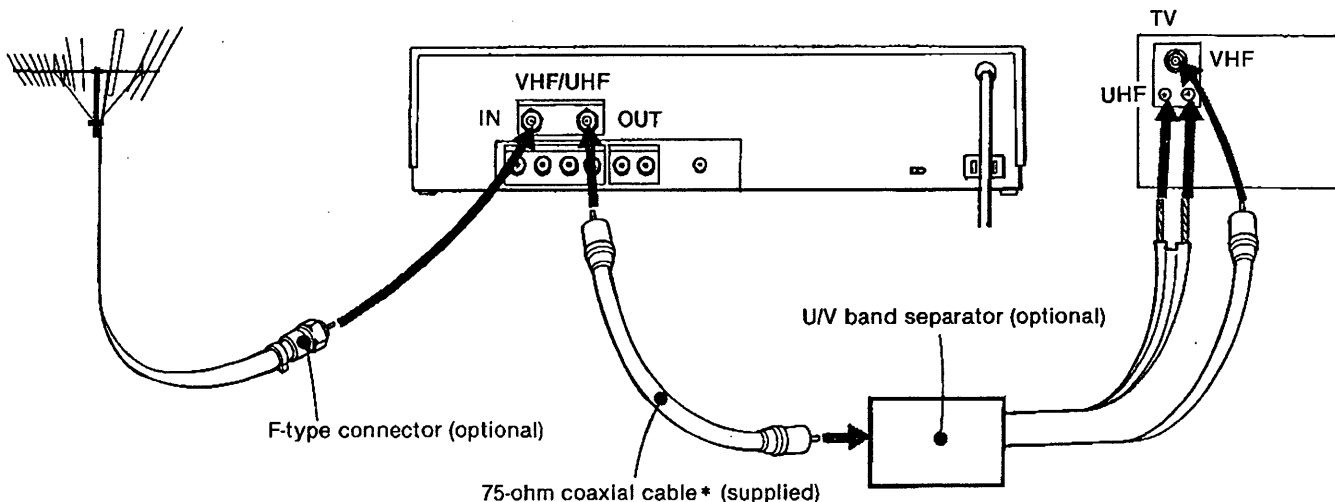

*Use an optional RFC-8 extension cable (available in the U.S.A. and Canada), 8 m (25 ft) long, if the supplied 75-ohm coaxial cable is not long enough.

If you need a separator or a complete antenna system, see your Sony dealer or a qualified technician.

VHF antenna

When the cable is a 300-ohm ribbon type lead-in (flat)

When the cable is a 75-ohm coaxial type (round)

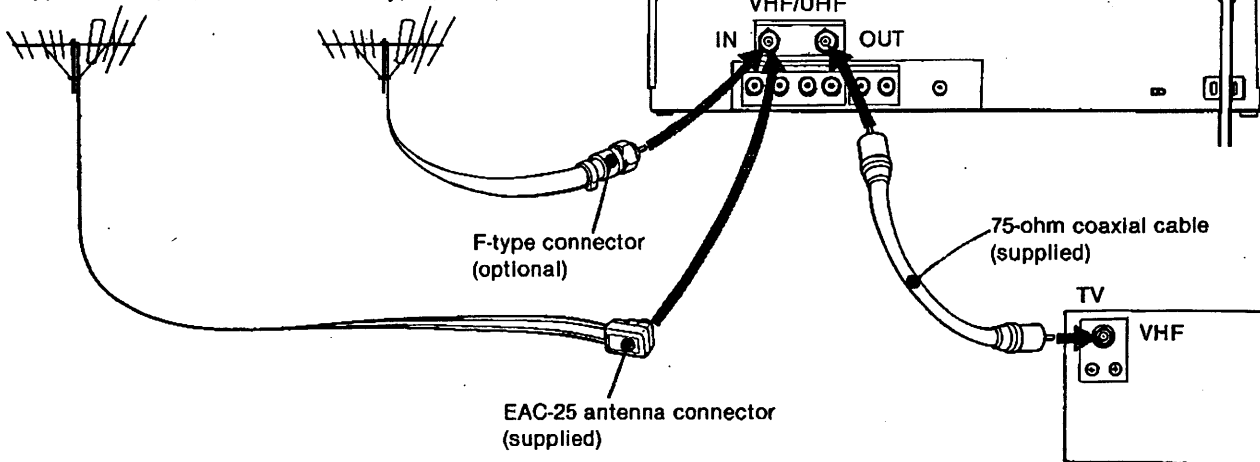

CATV cable

We recommend that you consult your cable company to make sure that the cable is properly connected.

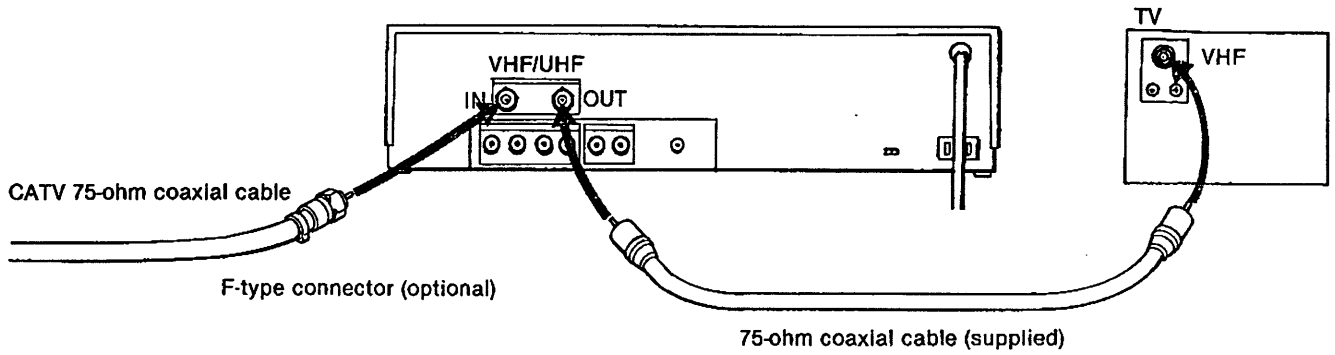

When a TV is not a CATV compatible type

Connect the CATV channel converter between the recorder and the TV so that you can watch another CATV program while recording one CATV program. (The TV/VTR button is set to TV.)

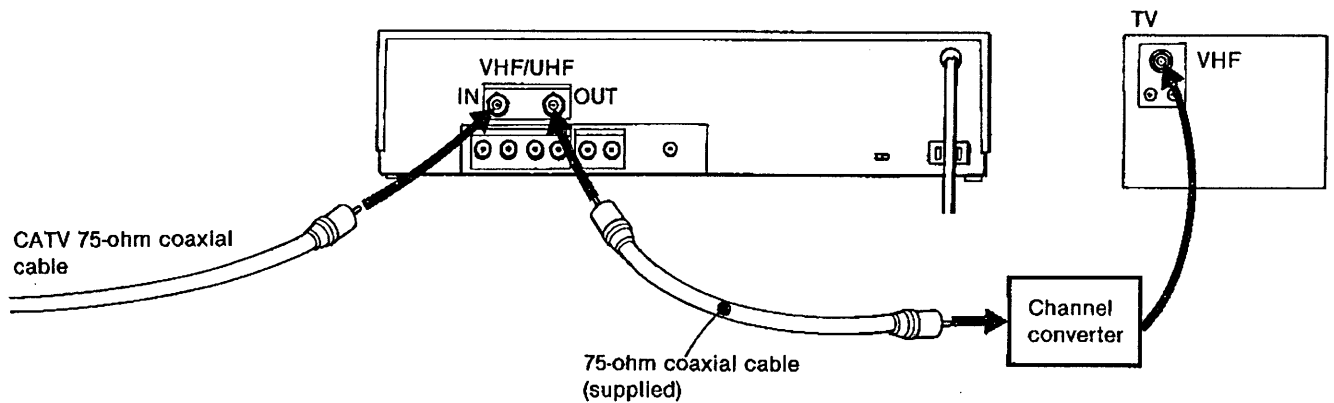

Note to CATV system installer in the U.S.A.:

This reminder is provided to call the CATV system installer's attention to Article 820-22 of the NEC that provides guidelines for proper grounding and, in particular, specifies that the cable ground shall be connected to the grounding system of the building, as close to the point of cable entry as practical.

How to attach an F-type connector

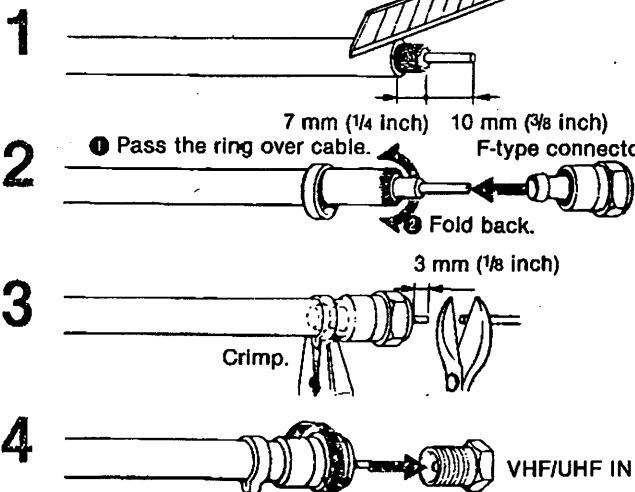

How to attach an EAC-25 external antenna connector

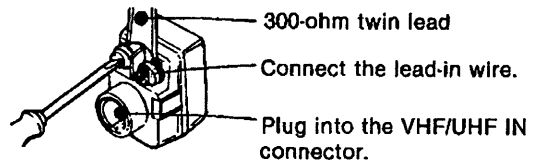

How to attach an EAC-66 U/V band separator (mixer)

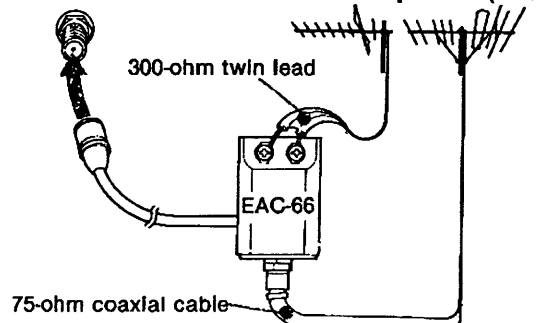

CONNECTING A COLOR MONITOR

To obtain a better-quality picture, connect a color monitor, such as the Sony Profeel Trinitron Component TV, instead of a conventional TV receiver. When a component TV is combined with the speaker system as illustrated, you can enjoy tapes recorded with Beta hi-fi stereo.

If you use a component TV tuner together with the monitor, connect the recorder and the TV tuner in the same way as in the case of the recorder and the conventional TV receiver described on pages 4 and 5. For details on the connection of the TV tuner and the monitor, refer to the instruction manual of the TV tuner.

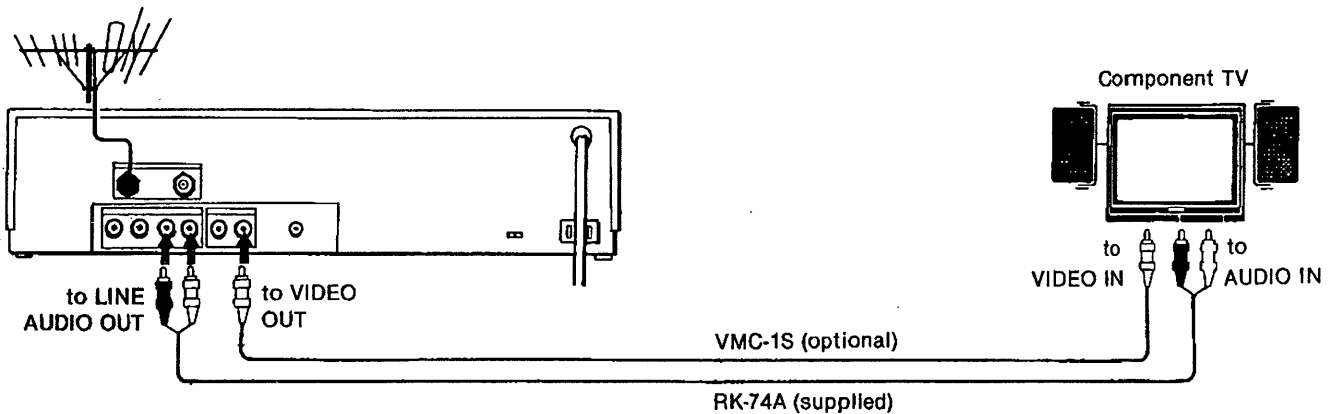

CONNECTION TO AN AUDIO SYSTEM

You can enjoy tapes recorded with Beta hi-fi stereo when the recorder is connected to your audio system.

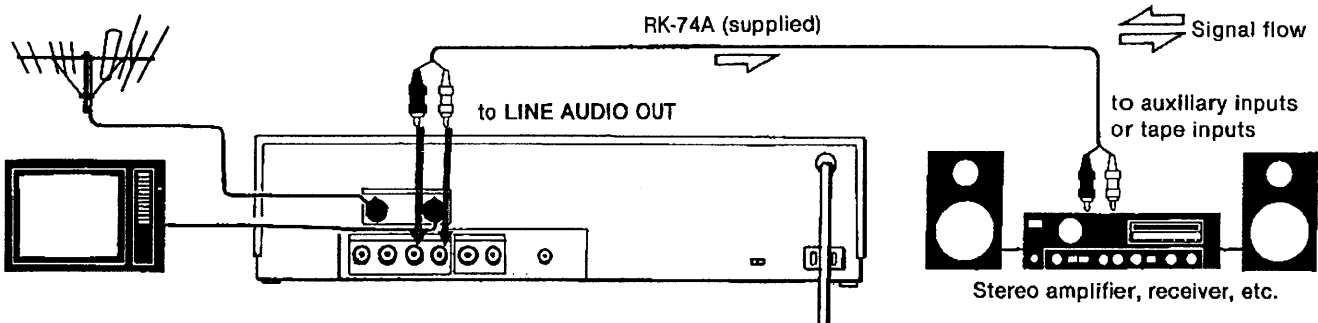

To record audio signals only from your audio system

You can record audio source such as an FM tuner, CD player, with the Beta hi-fi system without recording video signals.

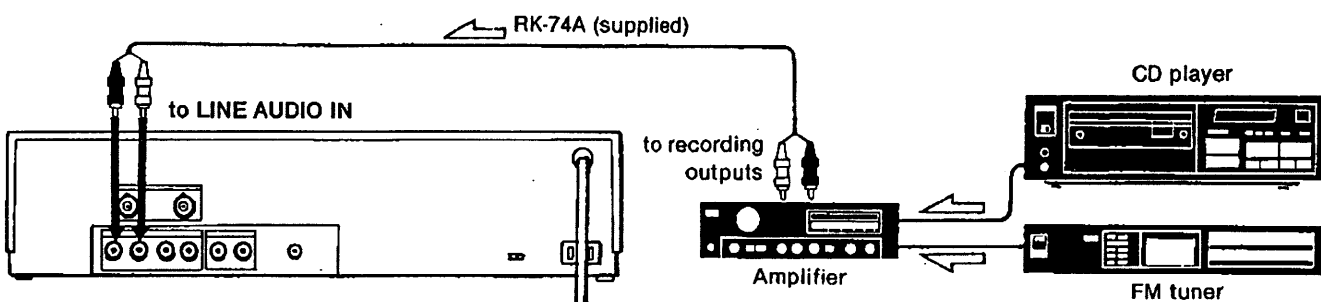

Connection to a receiver equipped with VIDEO connectors

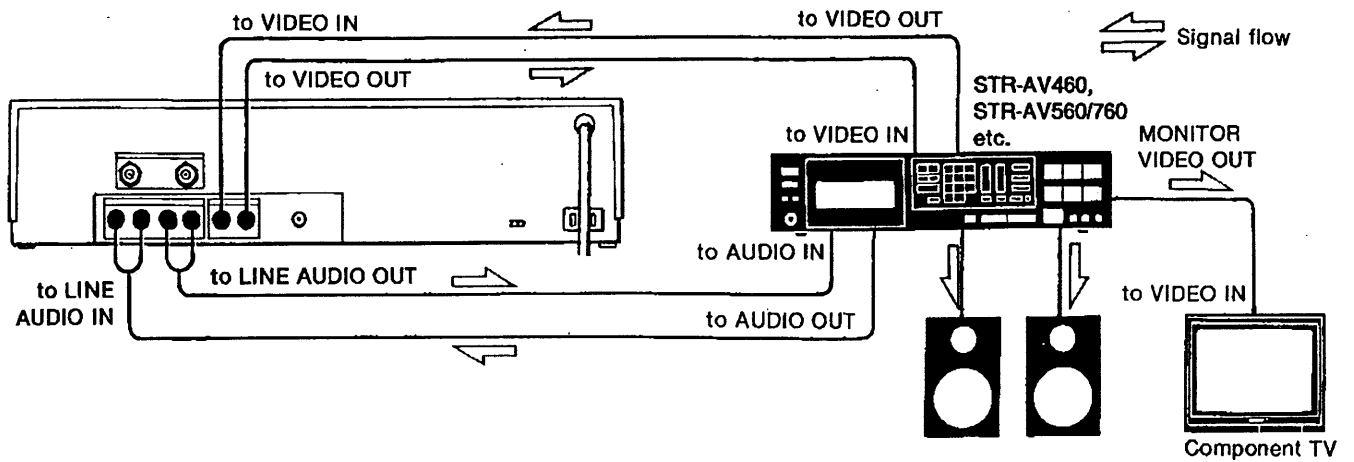

For details, see the instruction manual of the receiver.

Notes

- If the VCR is installed near a tuner or a radio, noise may be heard in AM reception. In this case, keep the VCR away from the tuner or the radio, adjust the AM bar antenna for minimum noise, or connect an external AM antenna to the tuner.
- Before connecting or disconnecting the power cord of the VCR, be sure to turn the connected amplifier off.

POWER CONNECTION

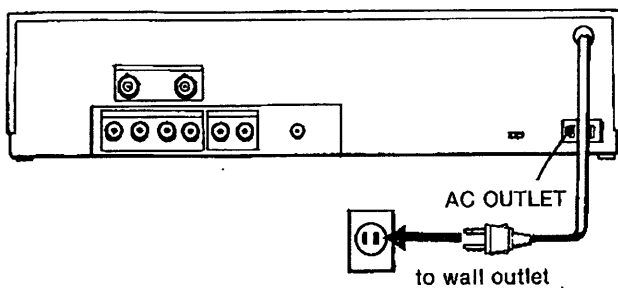

AC OUTLET

This socket provides a convenient ac power source for other video or audio equipment whose power consumption is under 400 watts. Power will be supplied to the connected equipment even if the recorder is turned off.

- Do not connect here any electrical home appliances whose power consumption exceeds 400 watts, such as an electric iron or fan.

When you insert the power plug into a wall outlet, all numerals in the display window will light up for about six seconds (and the tape loading mechanism may also run a little). All functions will not operate at this step, although the power indicator lights up. After these six seconds, the power is turned off. To supply power to the recorder, press the POWER switch.

ADJUSTMENT

ADJUSTING THE TV

Your TV receiver must be adjusted to receive the signal from your recorder. If you connect a color monitor, it does not need adjusting.

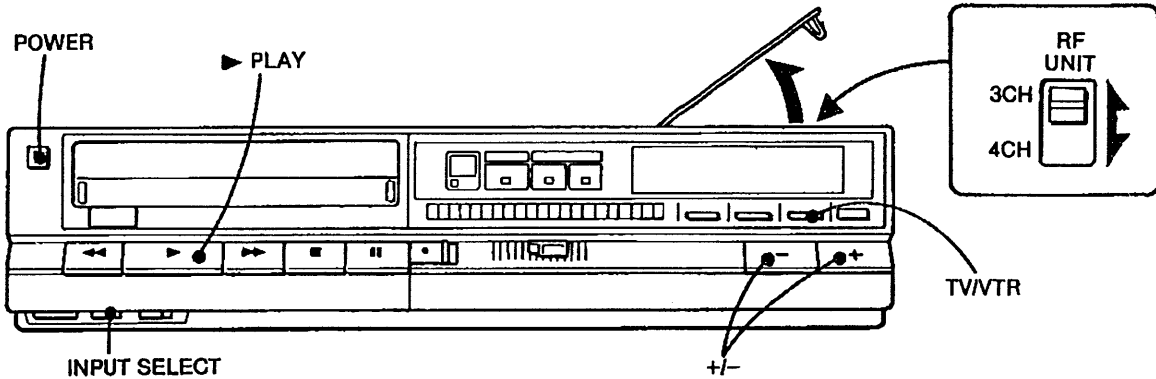

If you do not have a recorded video cassette tape

If you have a recorded video cassette tape

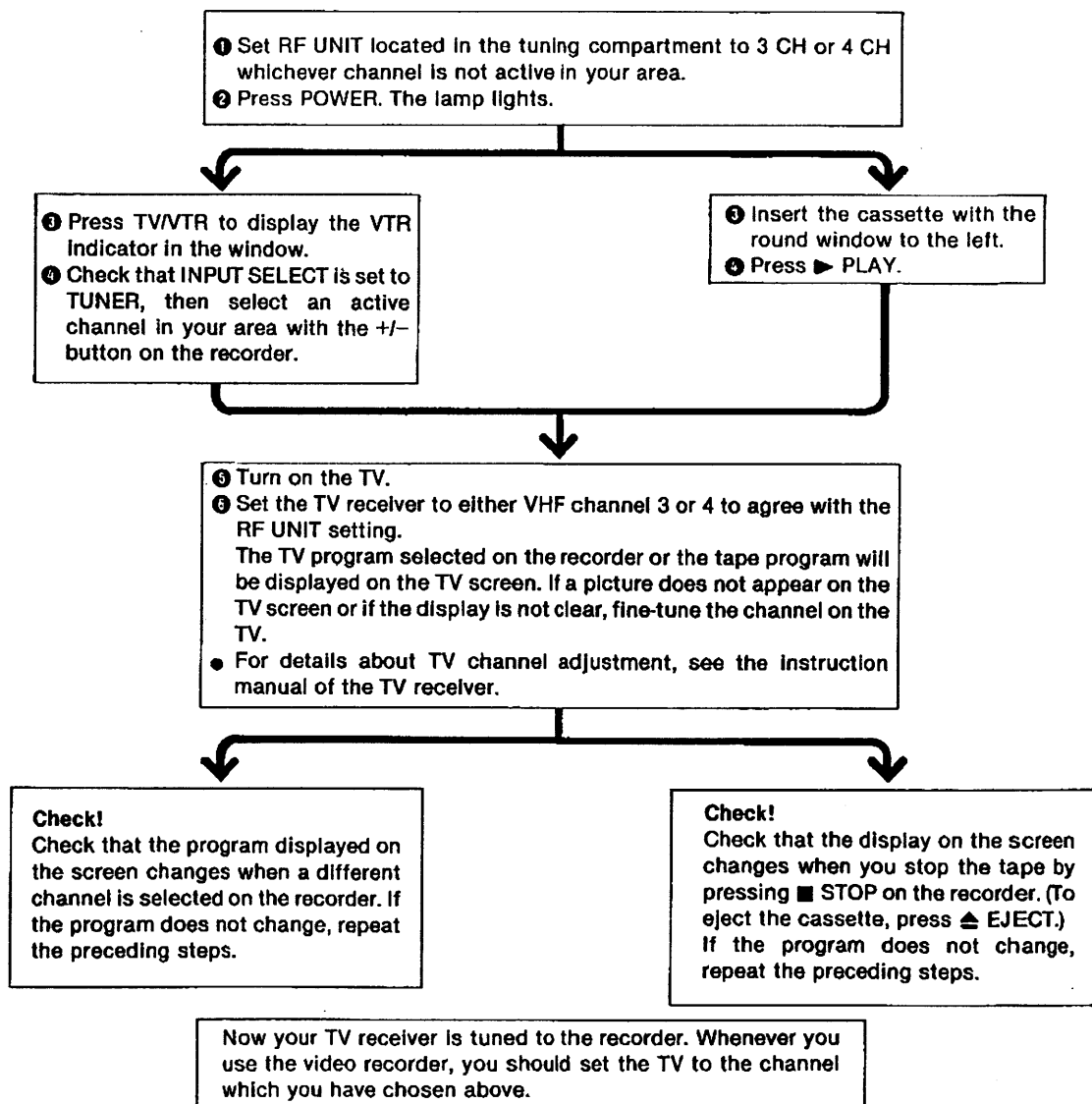

PRESETTING THE ACTIVE CHANNELS IN YOUR AREA

Your recorder is capable of receiving VHF channels 2-13, UHF channels 14-69 and cable TV channels 14-36 (A to W), 98 (A-2) and 99 (A-1). See cable TV channel chart below.

You can preset 14 channels so that only the desired channels will appear in sequence when you press the + or - channel button on the recorder and on the supplied Remote Commander.

To start presetting, turn on the recorder and set the INPUT SELECT switch to TUNER. Turn on the TV and select the channel to view the recorder's picture (channel 3 or 4).

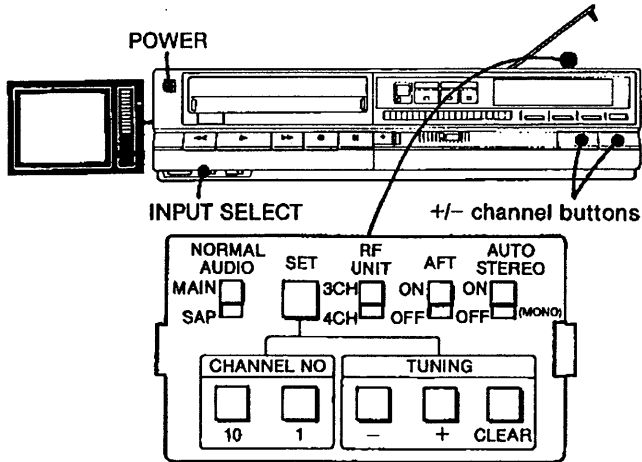

TUNING CHANNELS

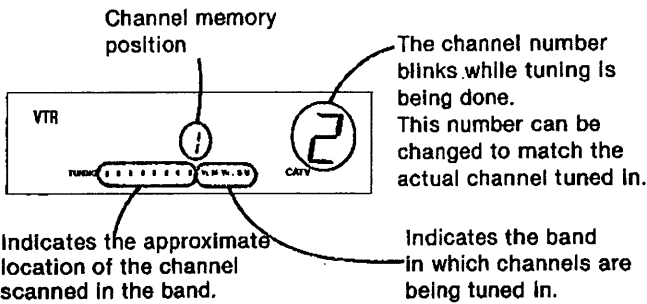

- 1 Press SET. The TUNING indicator will appear in the window.
- 2 Select the channel memory position with the + or - channel button for the desired channel to be tuned in.
- 3 Press + or - TUNING (on the tuning compartment) once. The first channel appearing on your TV will be memorized. If this is not the channel you wish, then repeat pressing TUNING + or - until the desired channel appears on your TV. Every time you press TUNING: a higher-numbered channel will be tuned in by pressing + and a lower-numbered channel by -.
- 4 Repeat steps 2 and 3 for other channel memory positions to be tuned in.
- 5 When all the desired channels have been tuned in, press SET. The display window will return to the clock indication. Making sure that AFT is set to the ON position, close the lid.

TO CHANGE THE CHANNEL DISPLAY

The channel number display at the far right of the indication window can be made to indicate the actual channel received.

Press CHANNEL NO "10" to change tens digit display and "1" to change the units digit display.

Every time "10" is pressed, the display changes:
Blank → 1 → 2 → 3...8 → Blank → 1 → 2 → 3

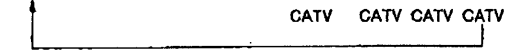

Every time "1" is pressed, the display changes:
0 → 1 → 2 → 3...9

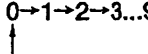

TO CANCEL AN UNUSED CHANNEL

You can cancel unused channels so that only desired channels will appear in sequence when you press the +/- channel buttons on the recorder and on the supplied Remote Commander.

- 1 Select the channel to be cancelled with the + or - button.
- 2 Press SET so that the TUNING indicator appears.
- 3 Press CLEAR. The channel number will be changed to "___".
- 4 Press SET again. The clock indication will appear. When the channel number buttons on the Commander are pressed, the sound of the cancelled channel will be muted.

TO FINE-TUNE A WEAK STATION

If the picture of a particular channel is not acceptable, set AFT to the OFF position and keep + or - TUNING pressed until the picture becomes clearer. Every time you select this particular channel, set AFT to the OFF position. (To view other channels, do not forget to set AFT to ON.)

Cable TV channel chart

Cable TV systems use letters or numbers to designate channels. To tune in a channel, refer to this chart.

CATV channels in numbers		98	99	14	15	16	17
CATV channels in letters		A-2	A-1	A	B	C	D
18	19	20	21	22	23	24	25
E	F	G	H	I	J	K	L
26	27	28	29	30			
M	N	O	P	Q			
31	32	33	34	35	36		
R	S	T	U	V	W		

Check with your local cable TV company for more complete information on the available channels.

*The designation of the cable TV channels conforms to the EIA/NCTA recommendation.

Note

Pay cable TV systems use scrambled or encoded signals and require special converters (decoders) in addition to the normal cable connection.

SETTING THE CLOCK

When you connect the ac power cord to a wall outlet, the clock indicates "Su AM 12:00" after 6 seconds and will blink to show that it must be set.

AM 12:00 = Midnight

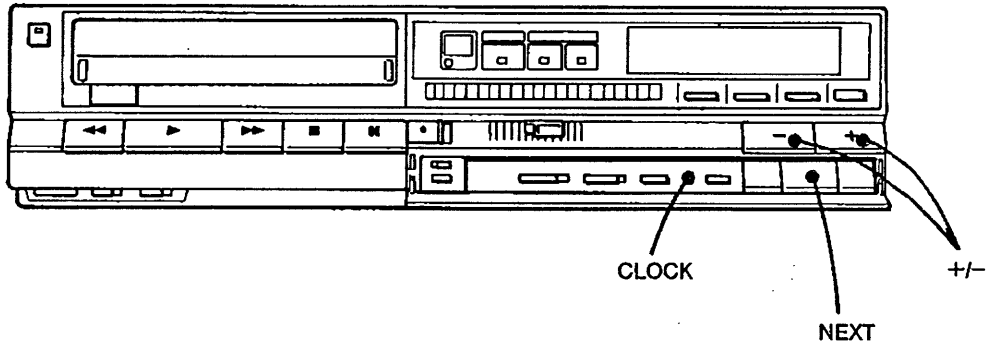

Example: To set for Wednesday afternoon at 3:56

1 Press CLOCK.

Set the day with the + or - button.

2 Press NEXT.

Set hours with the + or - button.

3 Press NEXT.

Set the minutes with the + or - button.

4 For accurate setting, press NEXT at the same time with an announced time signal.

The clock will now show the current time.

The dots of the colon (:) alternately blink every 30 seconds.

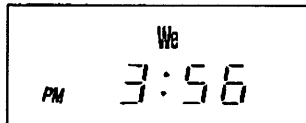
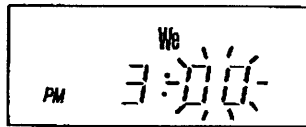
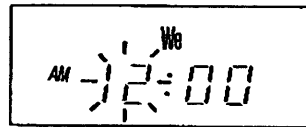
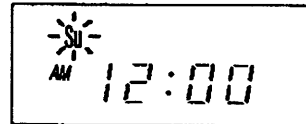

+/- buttons

The + and - buttons can be used in two ways:

When you keep the button pressed, the digits will advance continuously until the button is released.



When you press and immediately release the button, the digits will advance by one.



BASIC OPERATIONS

TV PROGRAM RECORDING

Note
The power is automatically turned on when a cassette is inserted, even though POWER is not pressed. However, this is to protect the unit from damage due to the insertion of a cassette without first turning on the power. Always turn on the power by pressing POWER before inserting a cassette.

Caution

Television programs, films, video tapes and other materials may be copyrighted. Unauthorized recording of such material may be contrary to the provisions of the copyright laws.

Also, use of this recorder with cable television transmission may require authorization from the cable television transmitter and/or program owner.

Check before recording

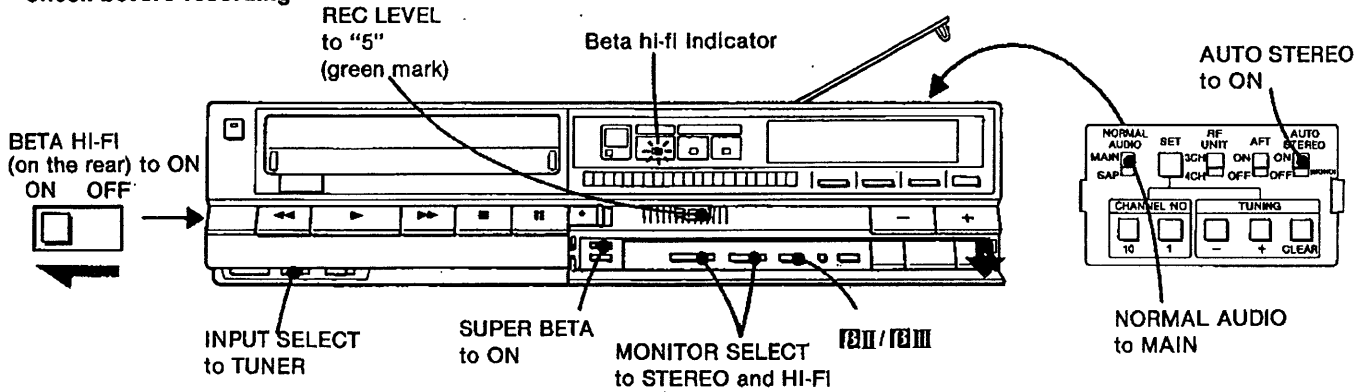

When BETA HI-FI is set to ON, recording is done both on the video track (Beta hi-fi recording) and on the conventional audio track.

Recording time available in each mode

Cassette used	II mode	III mode
L-125	30 min.	45 min.
L-250	1 hr.	1 hr. 30 min.
L-500	2 hr.	3 hr.
L-750	3 hr.	4 hr. 30 min.
L-830	3 hr. 20 min.	5 hr.

Recording

Numbers in the illustration show the sequence of operation.

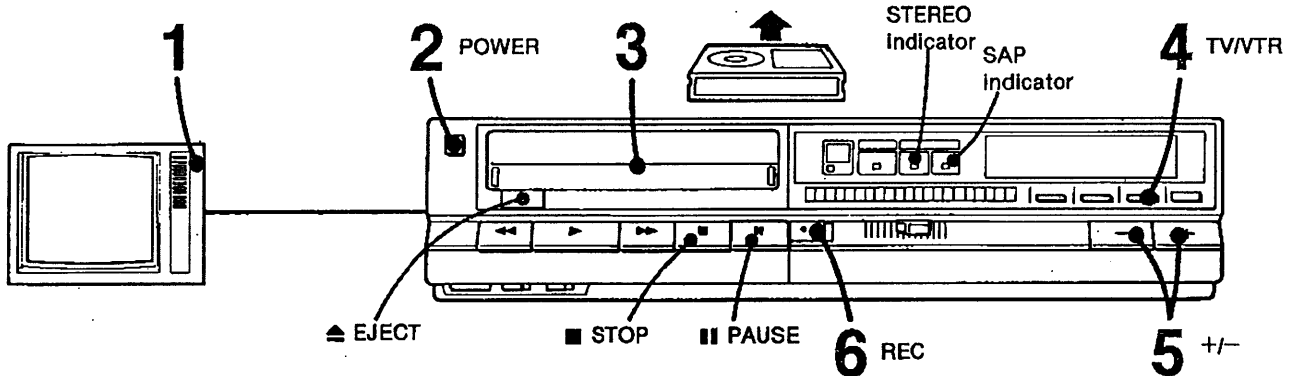

- 1 Turn on the TV and select the channel for the video recorder: channel 3 or 4.
- 2 Press POWER on the recorder to turn the power on.
- 3 Insert a cassette.
- 4 Press TV/VTR to select the VTR mode.
- 5 Select the channel to be recorded with the + or - button.
- 6 Slide REC to the right. Recording will start. If the tape reaches the end during recording, the tape will be rewound to the beginning automatically.

Check in the window

The numbers correspond to the step number of each recording operation.

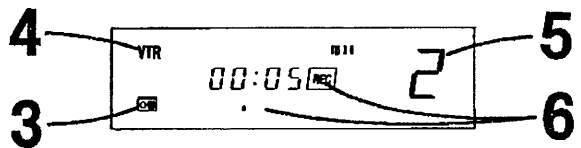

To stop recording, press ■ STOP.

To eject the cassette, press ■ STOP, then ▲ EJECT.

To stop the tape momentarily, press ■ PAUSE.

To resume recording, press the button again. If you do not resume recording more than about 8 minutes, the pause mode will be automatically released.

In case you want to record a tape which is to be played back on another recorder from the very beginning of the tape, run the tape for about 15 seconds before starting recording. Otherwise you may miss the starting point during playback on the other machine.

TO RECORD MULTICHANNEL TV SOUND (MTS) BROADCASTS (STEREOCASTS)

Make sure AUTO STEREO in the tuning compartment is set to ON.

In the years to come, an increasing number of programs will be broadcast in stereo. Called Multi-channel TV Sound or MTS, the new technology will greatly enhance TV viewing by bringing you programs with high fidelity stereo sound.

MTS also provides for an extra channel called the Second Audio Program or SAP which broadcasters can use to transmit a second language for bilingual transmissions or some other sound track.

To record a stereo broadcast

Set BETA HI-FI selector on the rear panel to ON. When the STEREO indicator lights up, a stereo broadcast is being received. The recording procedure is the same as usual.



To record a SAP (Second Audio Program) broadcast

Set NORMAL AUDIO to SAP. The SAP indicator will light up. If recording is made when there is a SAP broadcast, the SAP sound will be recorded on the conventional audio track while the MAIN sound is recorded on the video track in Beta hi-fi.

To listen to the SAP sound, set MONITOR SELECT to NORMAL.



To record a MAIN broadcast only

Set NORMAL AUDIO to MAIN. The MAIN sound will be recorded on the video track and the conventional audio track.

Note

- When a SAP sound is not to be recorded, be sure to set NORMAL AUDIO to MAIN. If it is set to SAP and there is no SAP broadcast, no sound is recorded on the conventional audio track.
- You may find more noise in the reproduction of the audio of SAP than in that of the main sound.

TO VIEW ONE TV PROGRAM WHILE RECORDING ANOTHER

Press TV/VTR so that the VTR indicator disappears from the display window. Select the channel you want to view on the TV.

TV/VTR



TO KEEP A RECORDED PROGRAM FROM BEING ACCIDENTALLY ERASED

When a new recording is made on a previously recorded cassette, the previous recording will be automatically erased.

To avoid erasing a recording

Break off the safety tab using a screwdriver or similar object. The cassette will be ejected automatically even when you slide REC to the right.



To re-record on a cassette which has had its safety tab removed

Cover the hole with a piece of plastic tape.



USE OF THE TAPE COUNTER

Turn on the power and press CLOCK/COUNTER to display the counter reading in the display window. To return the display to the present time, press CLOCK/COUNTER again.

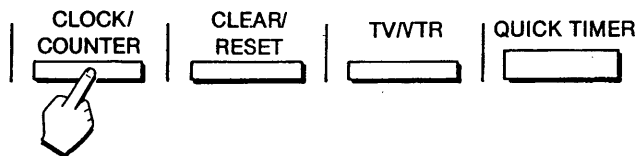

Before starting recording or playback, press CLEAR/RESET to set the counter to "00 00".

By noting the counter reading at the desired point, you can easily find that point later by referring to the counter.

Automatic playback or stop is possible at the tape counter "00 00" after rewinding. See "AUTO PLAY/STOP" on page 16.

Notes

- The counter reading is automatically reset to zero when a cassette is newly inserted.
- While the power is off, the display shows the present time, regardless of CLOCK/COUNTER setting.
- The counter reading will be retained in the memory even after the power is turned off, as long as the cassette is in the cassette compartment.
- The tape counter does not operate when a blank, unrecorded tape is played. Use it to find a blank part of the tape.

TO START RECORDING FROM A PARTICULAR POINT

You can decide the starting point for recording while watching the playback picture or by searching for the point using the Betascan and Beta SkipScan functions.

- 1 Search for the point where you wish to start recording on the tape by playing back the tape or using the Betascan or the Beta SkipScan function.
- 2 Press **||| PAUSE** to stop the tape where you wish to start recording.
- 3 Slide **REC** to the right. The recorder will enter the record pause mode and the picture selected by **INPUT SELECT** will appear on the monitor screen.
- 4 Press **||| PAUSE** to release the pause mode. Recording starts.

- At the starting point of recording, the picture may be distorted or streaks may appear.

NOTE

ABOUT THE SUPER BETA SWITCH

Normally keep this switch in the "ON" position to obtain high picture quality recording and playback. Tapes recorded in other non-SuperBeta VCRs can be played on SuperBeta VCRs. Tapes recorded in SuperBeta can be played on other non-SuperBeta VCRs: However, some over-modulation noise may appear in the picture during playback. If you intend to play back on other non-SuperBeta VCRs, then set the SuperBeta switch to "OFF" position when making your recordings.

PLAYBACK

Numbers in the illustration show the sequence of operation.

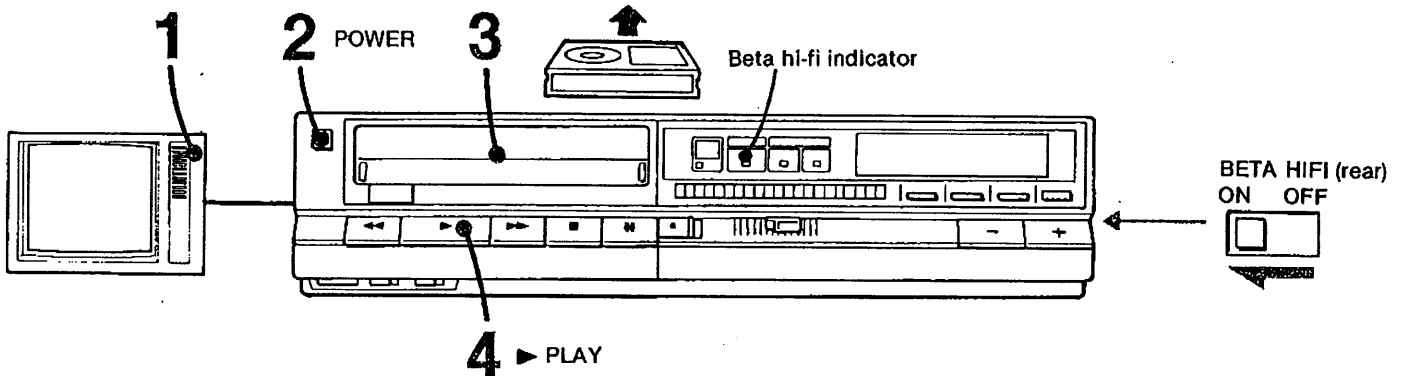

- 1 Turn on the TV and select the channel for the video recorder: channel 3 or 4.
 - 2 Press **POWER** on the recorder to turn the power on.
 - 3 Insert the cassette.
 - 4 Press **▶ PLAY**. Playback will start.
- If the tape reaches the end during playback, the tape will be automatically rewound to the beginning.
 - The Beta hi-fi Indicator will light up when a Beta hi-fi recorded tape is played back.

Check in the window

The numbers correspond to the step numbers of playback operation.

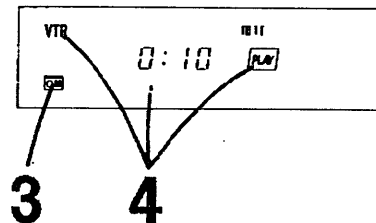

Note

- If you are playing back a tape that was recorded on another VCR, noise (if any) in the picture may be eliminated by setting the **SUPER BETA** switch to **OFF**. Normally, keep this switch at **ON**.
- To change to channel 3 or 2 on your TV from the channel on which you have been viewing something from the video recorder, be sure to press **TV/VTR** first and then change to channel 3 or 2 on your TV. If **TV/VTR** is pressed after channel 3 or 2 is set on your TV, you might not get a picture. In this case, change your TV channel to another channel and then come back to channel 3 or 2.

TO SELECT THE MONITOR SOUND



Playback of Beta hi-fi stereo sound programs
Set the above selectors to HI-FI and STEREO.

When the recorder is connected to a Component TV, a stereo system or stereo headphones, you can enjoy stereo sound reproduction.

When a conventional (monaural) TV is connected, the sound of the left and right channels are mixed so that monaural sound comes from the TV speaker.

To select the left or right channel of stereo programs
Set the above selectors to HI-FI and L or R. Select the position L or R to play back the channel you wish to listen to.

Playback of SAP sound
To listen to the SAP sound that was recorded by setting the NORMAL AUDIO selector to the SAP position, set the MONITOR SELECT (HI-FI/NORMAL) selector to NORMAL.

WHEN YOU PLAY BACK A TAPE RECORDED ON ANOTHER VCR

- If the VCR on which the tape was recorded is not equipped with the Beta hi-fi system, the recorder will play back the tape in the conventional way.
- If streaks or snow appear, adjust TRACKING for the best possible picture. Return the control to the center position after viewing that tape.



- To get a sharp picture, turn SHARPNESS toward SHARP.



VARIOUS PLAYBACK MODES

FREEZE PICTURE

Press **PAUSE** during playback.

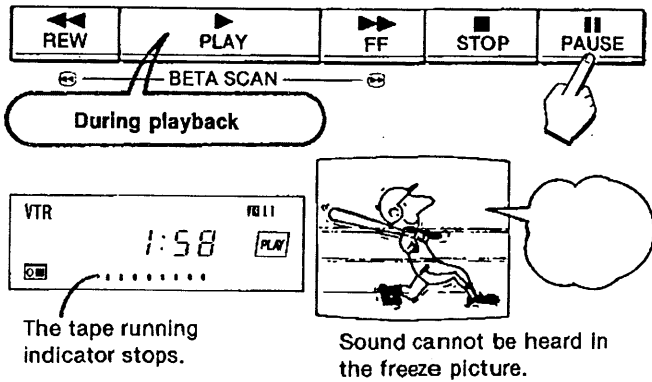

Automatic pause release

To protect the video heads and the tape, the pause mode will be automatically released after about 8 minutes and playback will resume.

BETASCAN Viewing the picture at a fast speed to find a particular scene

Press **FF** or **REW** during playback. When you release the button, the normal playback will resume.

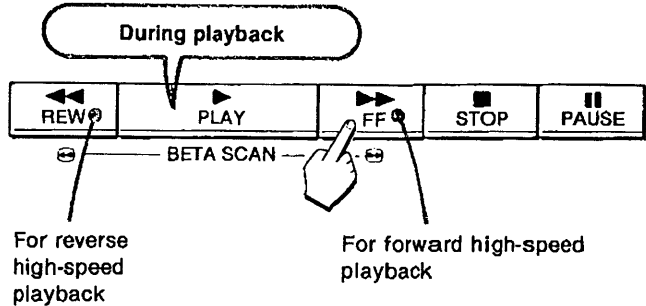

BETA SKIPSCAN Viewing the picture momentarily during fast-forward or rewind

Press **FF** or **REW** during fast-forward or rewind mode. When you release the button, the fast-forward or rewind mode will resume.

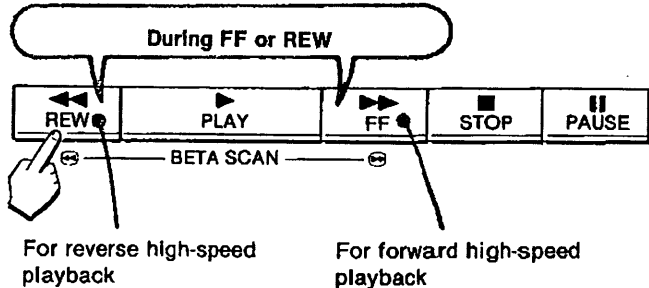

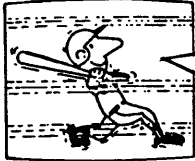

Streaks will appear and sound will be muted in the Betascan picture or Beta SkipScan picture.

Notes

- If the picture rolls vertically, adjust the vertical hold control on the TV.

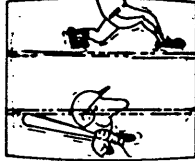

- During Betascan, the Beta hi-fi indicator may sometimes not light even when a Beta hi-fi recorded tape is played back.
- The pause, Betascan and Beta SkipScan functions cannot be activated with the recorded tape.

AUTO PLAY/STOP

To play a tape back from the beginning of the tape after rewinding
Set the display to the clock mode.
Press PLAY while holding REW depressed. After the tape is completely rewound, it will automatically be played back.

Clock display

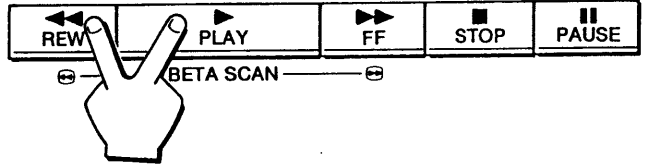
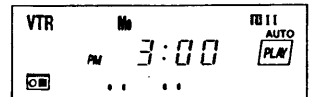

To play a tape back from the point at which the tape counter has been set to "00 00" after it has been re-wound

Press CLOCK/COUNTER to change the display window to the tape counter. Set the counter to "00 00" by pressing CLEAR/RESET at the point at which you wish to begin playback.
Press PLAY while holding REW depressed. The tape will be played back automatically beginning at the "00 00" point in the display window.

Tape counter display

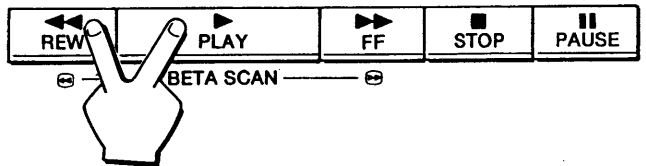
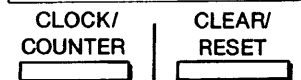
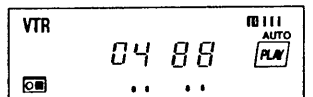

To stop the tape at the "00 00" point after it has been re-wound

The same operation as the above except when the tape is rewound, press STOP while holding REW depressed.

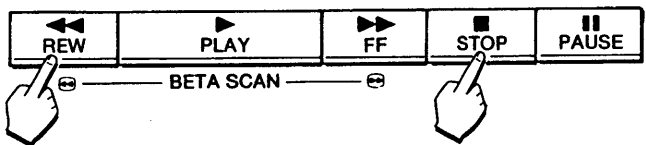

Auto play and stop at the "00 00" point operates only in the tape counter mode.

TIMER-ACTIVATED RECORDING

This timer can only be used to start and stop recording.

The timer can be set to record up to six different programs on any one day or in any period of seven consecutive days.

Check before setting the timer

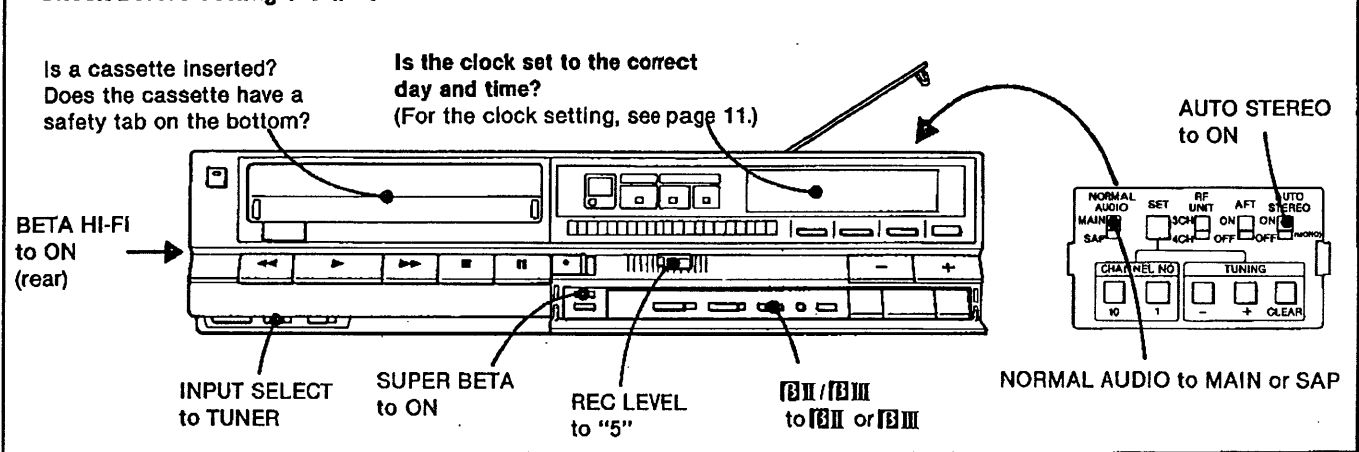

SETTING THE TIMER

Suppose you want to make a recording of channel 6 from 7:10 to 11:15 on Friday evening.

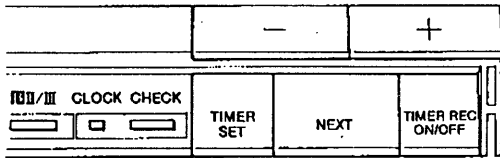

Every time you press NEXT, the item to be preset next flashes. Do not forget to press NEXT, otherwise the presetting process does not advance to the next step. To set the appropriate day, time, and channel, press the + button to advance and the - button to go back.

Check in the window

Flashes alternately

1 Press **TIMER SET**.
The first empty program position will be selected automatically.

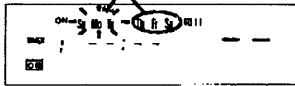

2 Set the day with the + or - button.

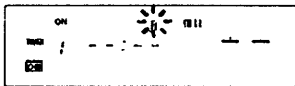

3 Press **NEXT**.
Set the hour with the + or - button.

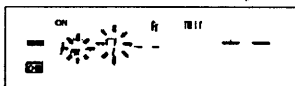

4 Press **NEXT**.
Set the minutes with the + or - button.
The turn-on time for recording has been preset.

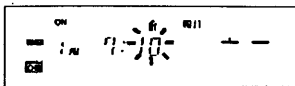

5 Press **NEXT**.
Now, turn-off time must be preset.
Set the hour with the + or - button.

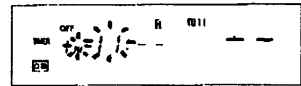

6 Press **NEXT**.
Set the minute with the + or - button.

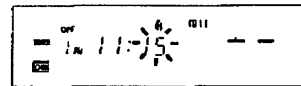

7 Press **NEXT**.
Set the channel with the + or - button.

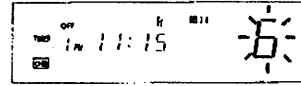

8 Press **NEXT**.
The memorized turn-on and, turn-off times will be displayed for about 3 seconds, then the current timer will appear.

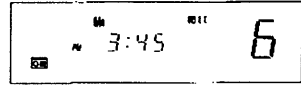

To preset more programs, press **TIMER SET** again to display another empty program position. Repeat all steps above.

When the six programs have been fully preset, the window will continue to show the current time even if **TIMER REC ON/OFF** is pressed. To know what you have preset, press **CHECK**.

9 To activate recording mode for the preset time:
Press **TIMER REC ON/OFF**.

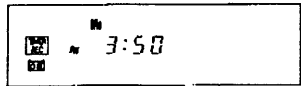

The power will be turned off and the recorder will be in the standby mode.

Recording will start automatically at the preset turn-on time and will stop at the preset turn-off time. The memory of the program except everyday setting will be erased and the program positions preset in the timer will advance one by one.

ONCE THE TIMER REC INDICATOR HAS LIT UP, only the CHECK and TIMER REC ON/OFF functions can be activated.

To release a timer-activated recording before it starts
Press TIMER REC ON/OFF. The memory will be retained. To reactivate the timer recording standby mode, press TIMER REC ON/OFF again.

To stop timer recording momentarily

Press **||** PAUSE.

To resume recording, press the button again within about 8 minutes.

When the tape ends during timer recording

The tape stops but the tape will not be rewound to the beginning.

To record the entire tape

Set the turn-off time to exactly the same time as the turn-on time. Recording will continue to the end of the tape, after which the recorder will be turned off.

To record a broadcast program at the same time every-day

If you want to make a recording for everyday at the same time on the same channel for the same duration, set the indicator so that all days of week appear.

TO CHECK THE TIMER SETTING

Press CHECK. Every time you press CHECK, successive preset timer settings will be displayed.

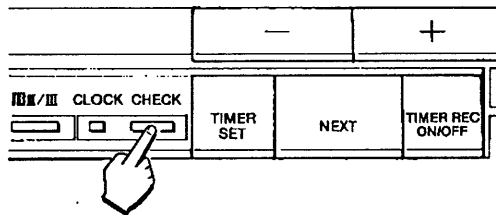

TO CHANGE A TIMER SETTING

- 1 Press CHECK until the setting to be changed appears.
- 2 Press TIMER SET.
- 3 Press NEXT until the setting to be changed blinks.
- 4 Change the setting with the + or - button.
- 5 Press NEXT until the current time appears.

TO ERASE THE MEMORY OF A PARTICULAR PROGRAM POSITION

Press CHECK until the setting to be erased appears and press CLEAR/RESET. The memory of the program will be erased.

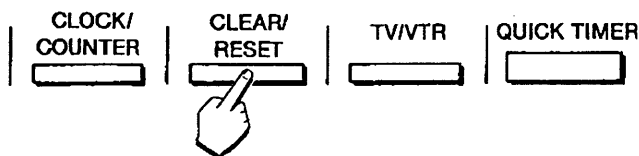

QUICK TIMER RECORDING

NOTES ON TIMER RECORDING

Troubles when TIMER REC is pressed

TIMER REC and  indications blink in the window and the cassette will be ejected automatically.



Check
The cassette inserted has the safety tab removed.

TIMER REC and  indications blink in the window for a few seconds and disappears.



The tape is at its end.

TIMER REC does not appear in the window.



No cassette is inserted.

When the presettings of your timer-activated recordings overlap

There will be no error indication to inform you of the overlap. Even if there is an overlap, a recording will be made.

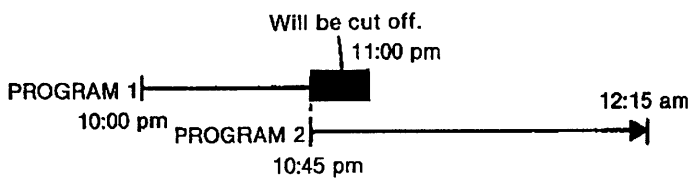

The recording of program 2 will begin before program 1 is finished.

If a power interruption occurs during timer recording

If the clock shows "AM 12:00" and blinks

When the recorder is in the standby mode, all the timer settings have been erased. Reset the clock and timer setting.

When the timer-recording is activated, the recording will stop.

If the clock goes slow

An interruption of less than a few seconds will not affect the memory of the timer.

The timer memory will be retained and timer recording will be performed although the clock remains as it goes slow by the amount of the interruption.

Use this function to begin recording a program immediately and to turn off the power automatically.

You can start timer recording immediately by pressing QUICK TIMER for up to 5 hours by 30 minutes. You can also use this function to extend the non-timer recording of a particular channel.

TO USE QUICK TIMER FROM THE TAPE STOP MODE

Make sure that the cassette is inserted.

1 Press QUICK TIMER.

While the channel number blinks, you can change the channel. If you do not advance to the next step, the recorder will turn off after about 30 seconds.

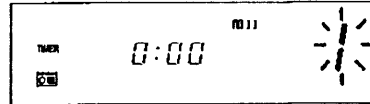

2 Press QUICK TIMER again.

The recording will start instantly.

Choose the recording duration.

Every time you press QUICK TIMER, the indication changes:

0:30 → 1:00 → 1:30 → 2:00 5:00 → 0:00

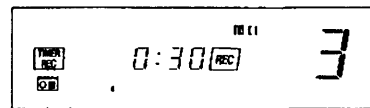

When the recording starts, the time indication decreases minute by minute to 0:00 and the recorder turns off automatically.

TO USE QUICK TIMER WHILE RECORDING

Press QUICK TIMER as many times as required to choose recording duration. Recording will continue within the selected time duration.

Once the quick timer recording has started

No function button except for the following will activate:

QUICK TIMER.....to change recording duration
TIMER REC.....to Interrupt quick timer recording
PAUSE.....to stop quick timer recording momentarily
CHECK.....to check timer programs preset

When a power interruption occurs during quick timer recording

The recording stops.

It will start again if the power is supplied within few seconds.

When the tape comes to an end before the preset turn-off time

The recording stops and the recorder will be automatically turned off after about 30 seconds.

ADVANCED OPERATIONS

BETA HI-FI AUDIO RECORDING

RECORDING FROM YOUR AUDIO SYSTEM

To connect the recorder to your audio system, see page 7. Set the switches as shown below. To start recording, insert a cassette and slide REC to the right.

Manually adjust the recording level. Set REC LEVEL so that the first red element lights up only at the highest signal level.

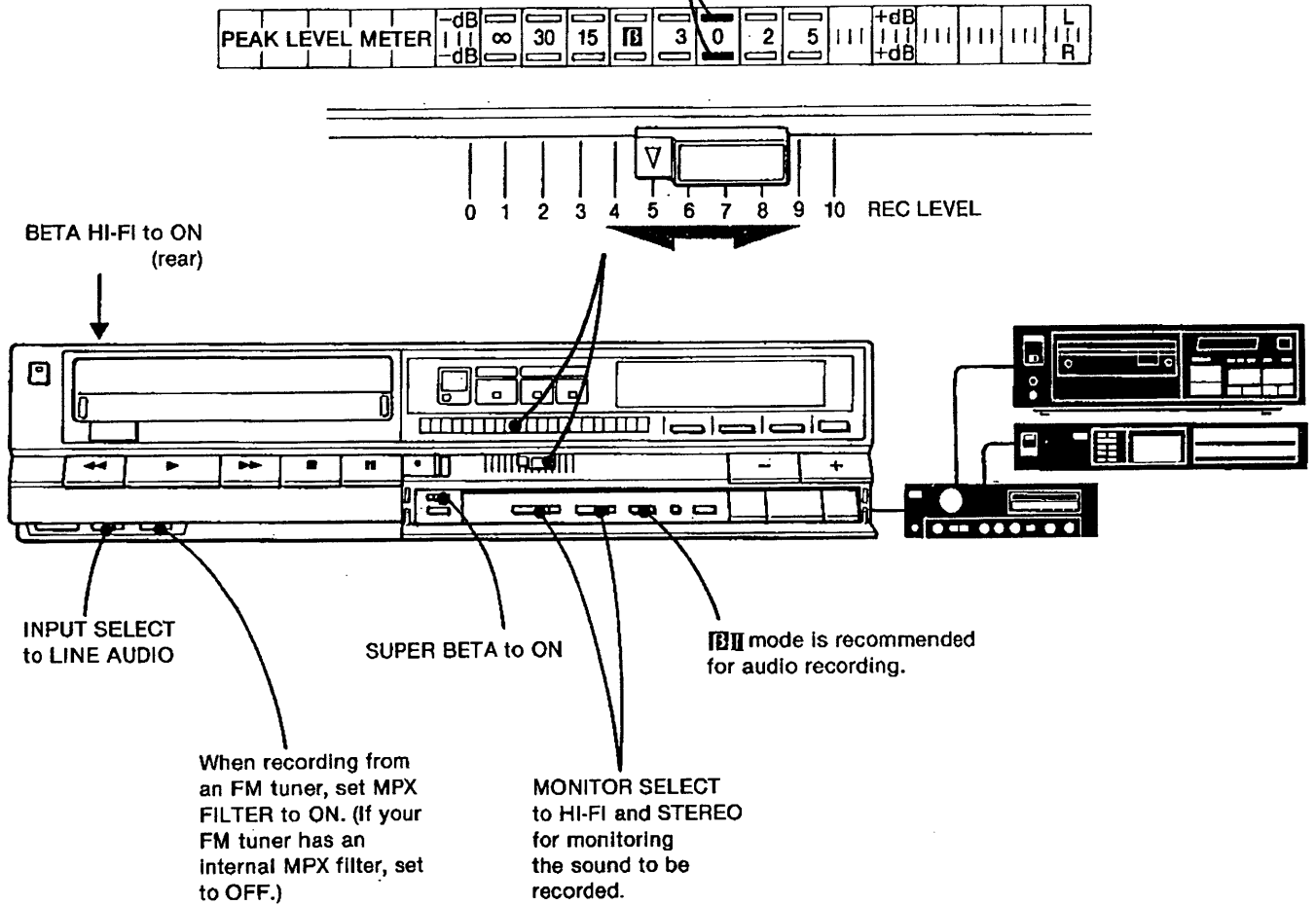

FM SIMULCAST RECORDING

By connecting an FM stereo tuner to the LINE AUDIO IN jacks besides the CATV cable connection, you can record a CATV program with stereo sound, such as MTV (music TV), whose audio signals are divided into the FM tuner from the cable.

For FM simulcast recording, set INPUT SELECT to LINE AUDIO. The sound from the FM tuner is recorded on the video track (Beta hi-fi recording), while the TV sound is recorded on the conventional audio track.

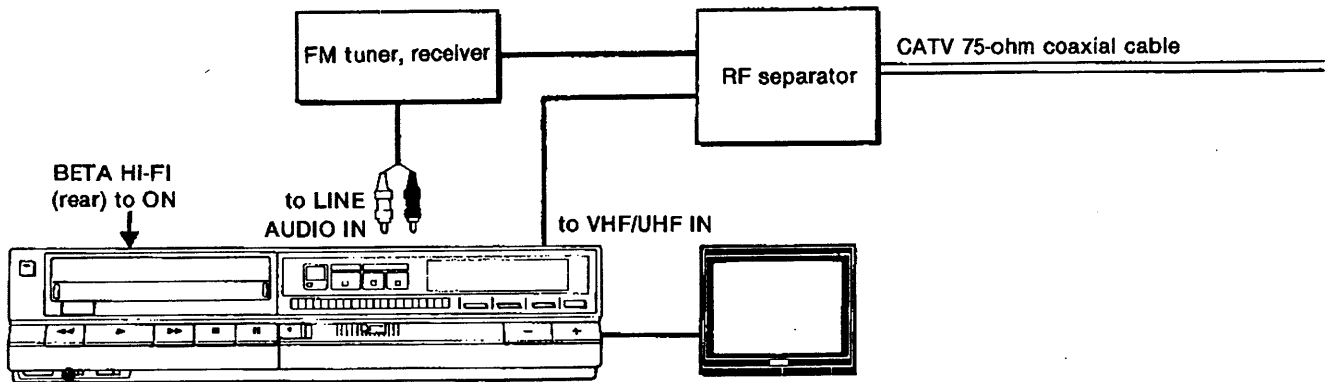

TIMER-ACTIVATED FM RECORDING

Use an optional program timer to turn the audio system on and off.

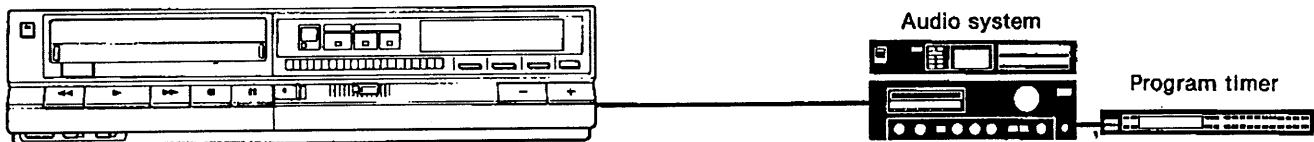

The settings of the controls is the same as in "RECORDING FROM YOUR AUDIO SYSTEM". Set the recorder's timer and a program timer to the

same turn-on and turn-off time. The settings on the recorder's timer are the same as in "TIMER-ACTIVATED RECORDING" on page 17.

PCM RECORDING AND PLAYBACK

Connect a PCM digital audio processor as shown below.

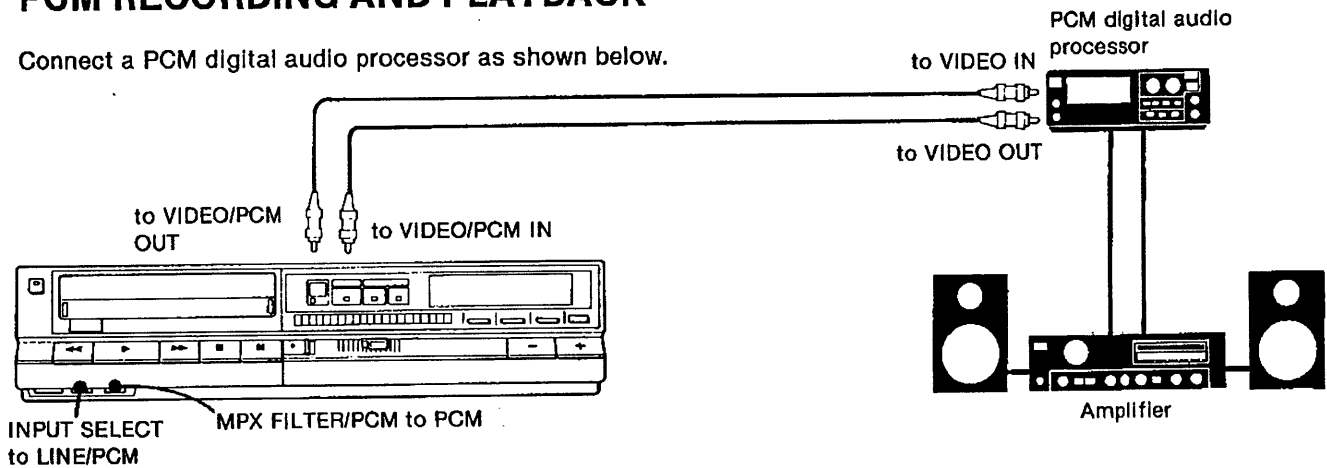

For PCM recording, set INPUT SELECT to **LINE/PCM** and MPX FILTER/PCM to **PCM**. For optimum results, use a video cassette with a model number of L-500 or

below (L-250, L-125, etc.) and select tape speed **II**. For details, refer to the instruction manual furnished with the digital audio processor.

CAMERA RECORDING

CONNECTIONS

- The camera must conform to American TV (EIA) standards.
- The use of a Sony HVA-220 ac adaptor is required.

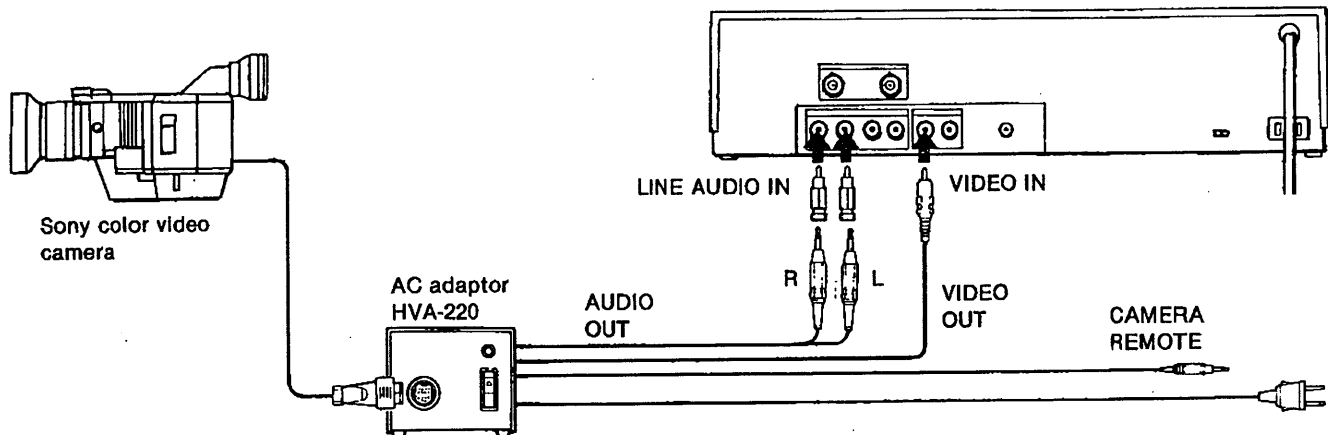

OPERATION

Set INPUT on the recorder to **LINE/PCM**. To start recording, slide REC on the recorder or on the Remote Commander to the right. To stop recording, press **■ STOP** on the recorder or on the Remote Commander.

To stop recording momentarily, press **|| PAUSE** on the recorder or on the Commander. The tape run/stop button on your camera will not function with this recorder.

REMOTE CONTROL OPERATION

You can control almost all the functions of this video cassette recorder from your armchair using the supplied Remote Commander.

BATTERY INSERTION

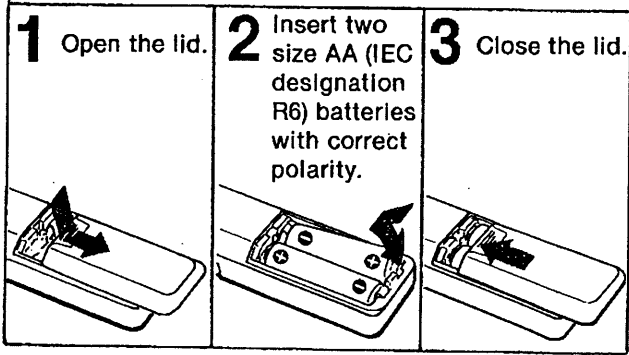

Battery life

In normal operation, batteries will last for about six months. If the range of the Remote Commander becomes noticeably shorter, replace the batteries with new ones. When the batteries are exhausted, the indicator will not light when the buttons on the Commander are pressed.

If the Remote Commander is not to be used for a long period of time, remove the batteries to avoid possible damage from battery leakage.

OPERATION

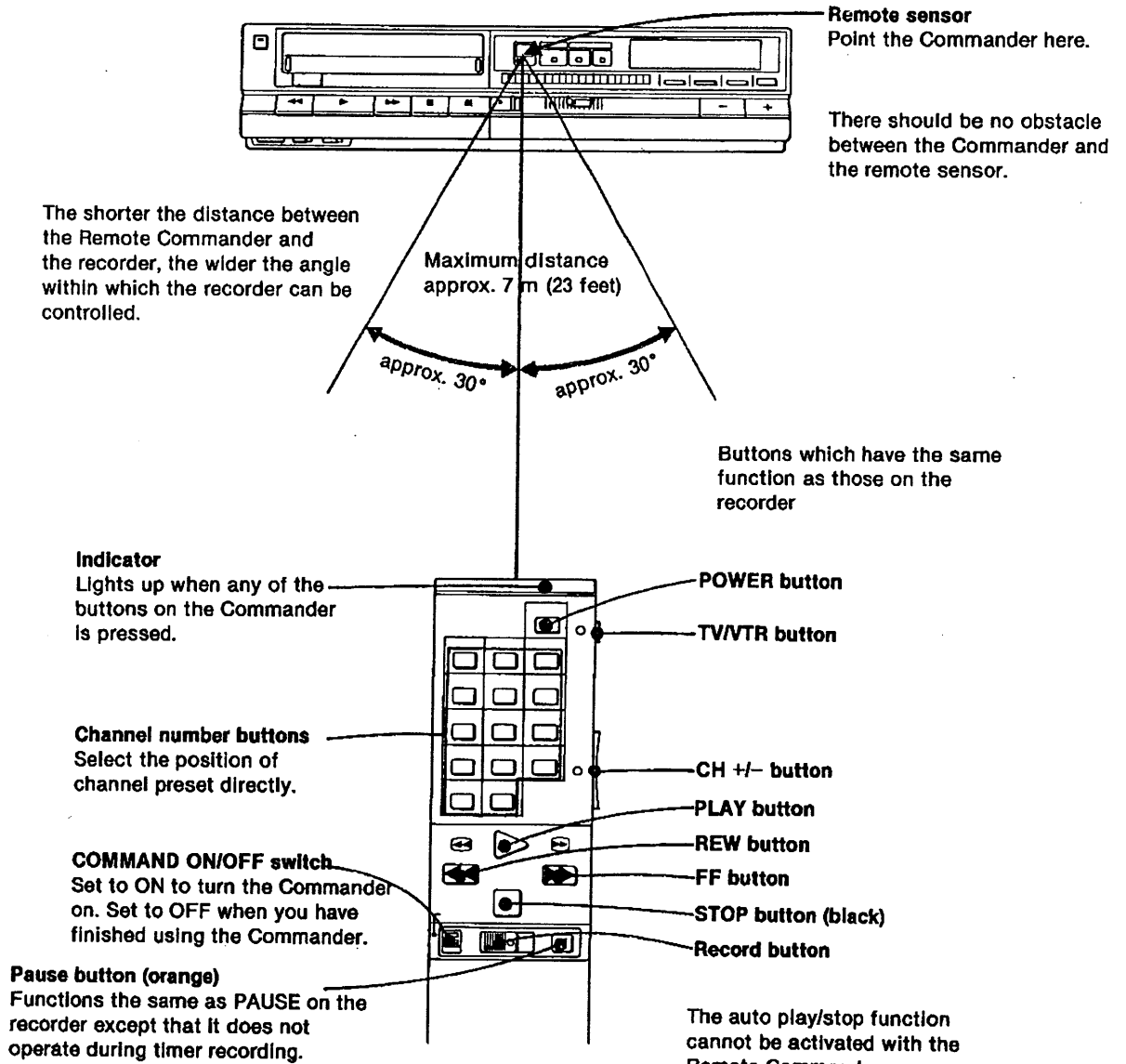

EDITING A TAPE

To edit a home movie tape, you will need two video cassette recorders. Set the controls as shown below. To start recording, set the VCR for playback in the playback mode, then press the record button on the other VCR.

To edit a home movie tape from another VCR to the SL-HF400

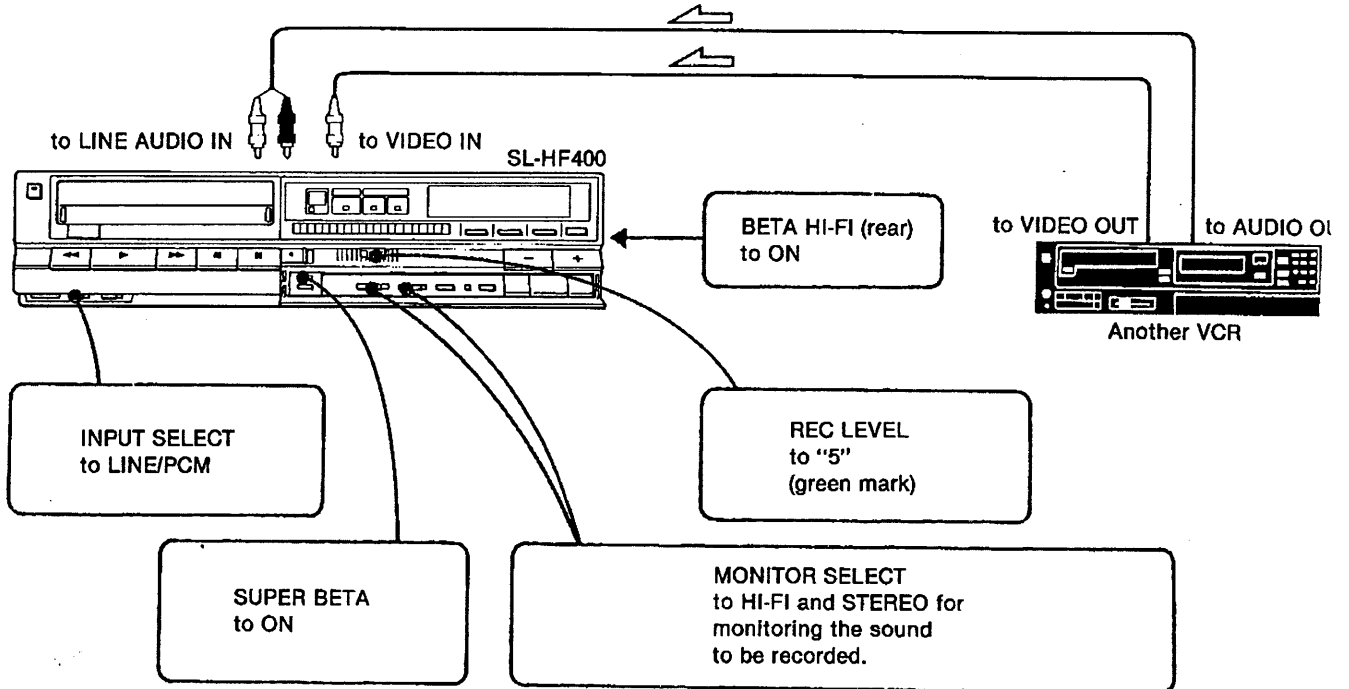

To edit a home movie tape by recording a tape played back on the SL-HF400 to another VCR

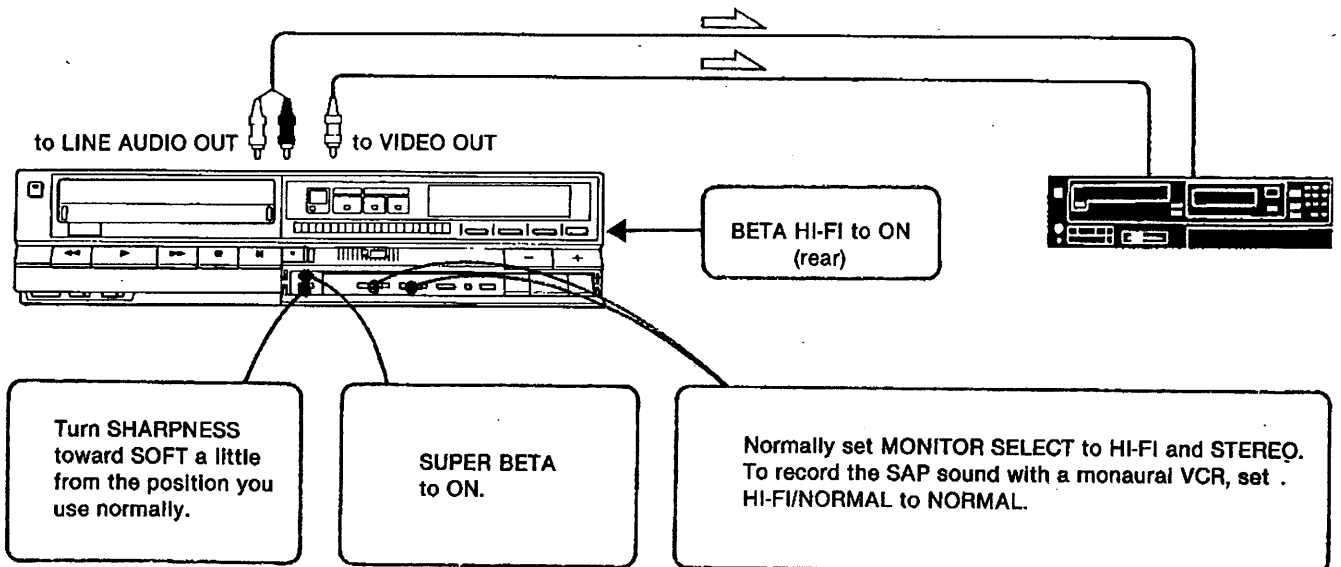

CAUTION

Television programs, films, video tapes and other materials may be copyrighted. Unauthorized duplication of such material may be contrary to the provisions of the copyright laws.

TO EDIT FROM A VCR EQUIPPED WITH THE CONTROL S (EDIT) OUTPUT

Only the particular scenes preset on the playback VCR will be edited (automatic assemble editing). Recording start/stop on the SL-HF400 can be activated in synchronization with playback start/stop on the playback VCR.

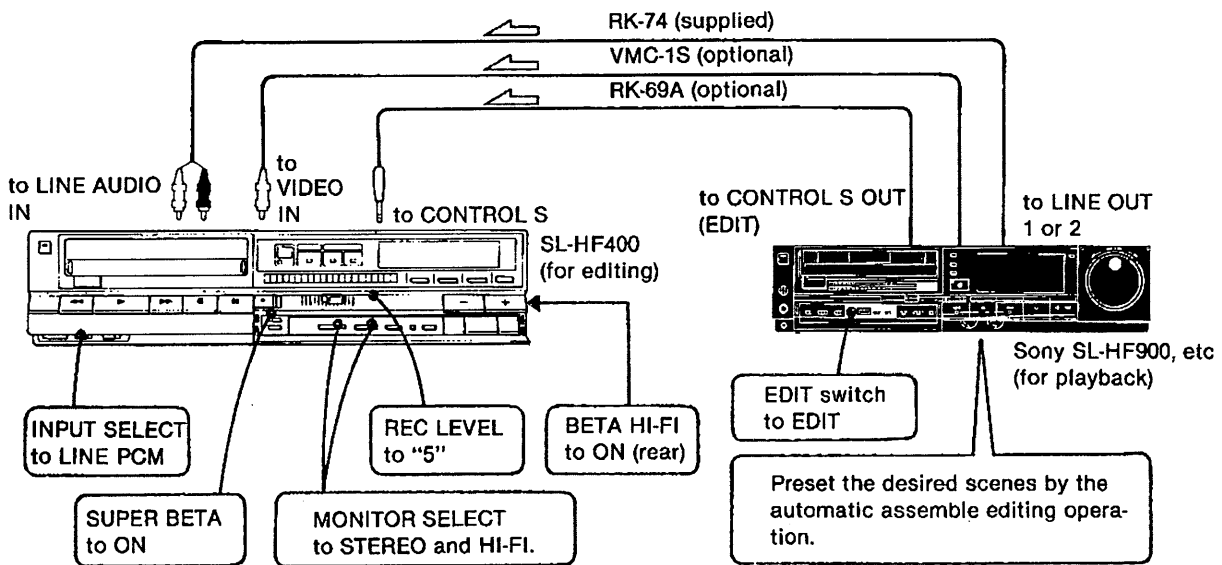

To start editing, set the SL-HF400 in recording pause mode and then follow the instruction manual of the playback VCR for the automatic assemble editing.

- The optional RM-E100 video editing controller allows easier editing between two VCRs.
- The required connecting cords may differ depending on VCRs. Refer to the instruction manual of the VCR.

Note

Avoid repetition of editing tapes, as the picture and tone quality will be impaired noticeably for newly edited tapes.

Use of the CONTROL S input jack

If this jack is connected to the CONTROL (S) OUT jack of a Sony color TV or TV tuner, this recorder can be controlled by pointing the supplied RMT-124 Remote Commander toward the remote sensor on the color TV or TV tuner.

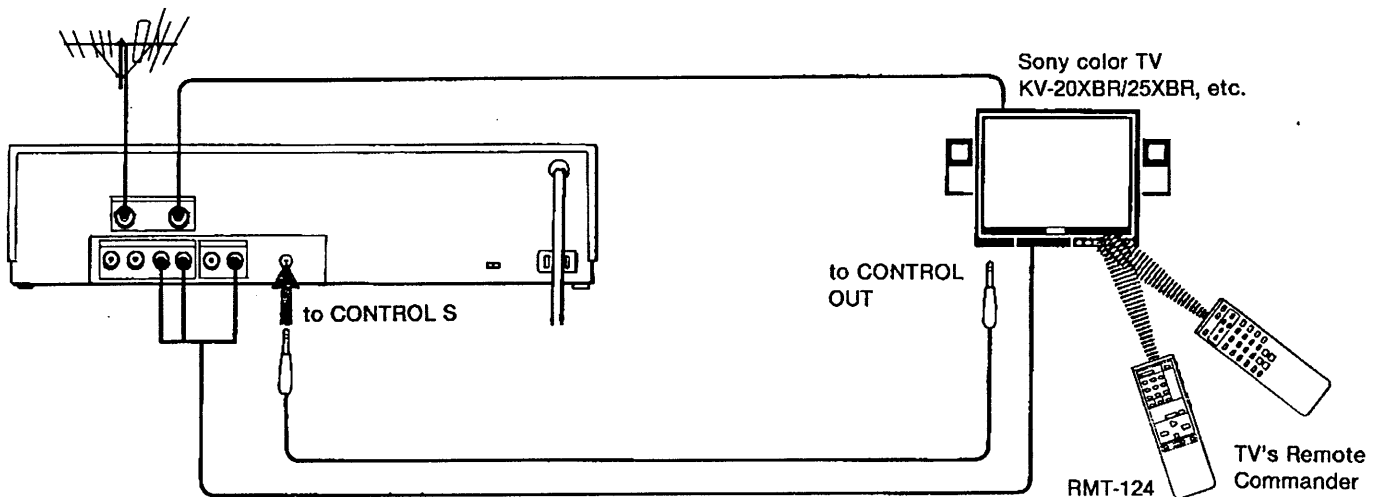

GENERAL

LOCATION AND FUNCTION OF CONTROLS

Front

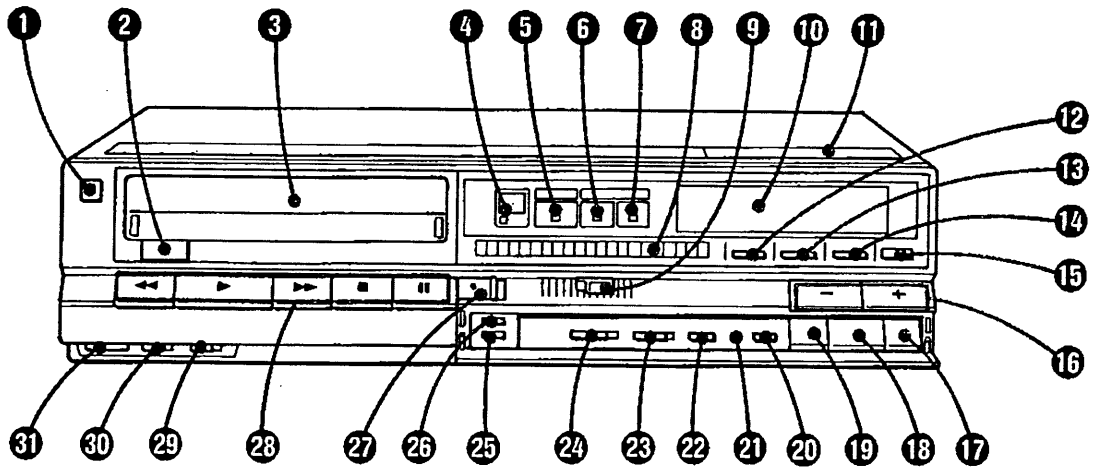

⑩ Display window

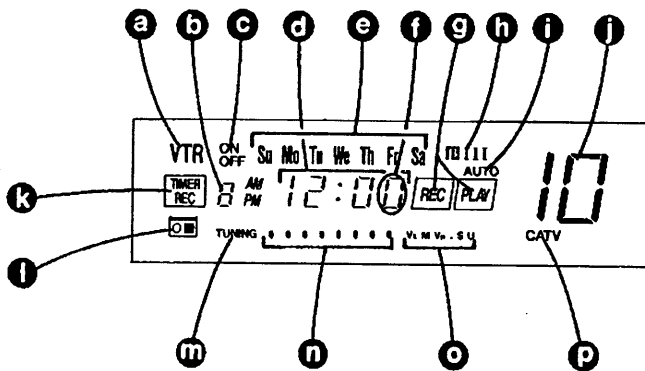

⑪ Tuning compartment

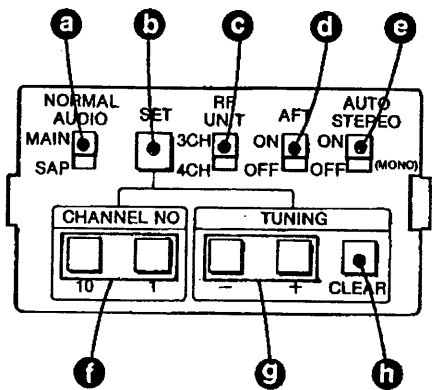

Rear

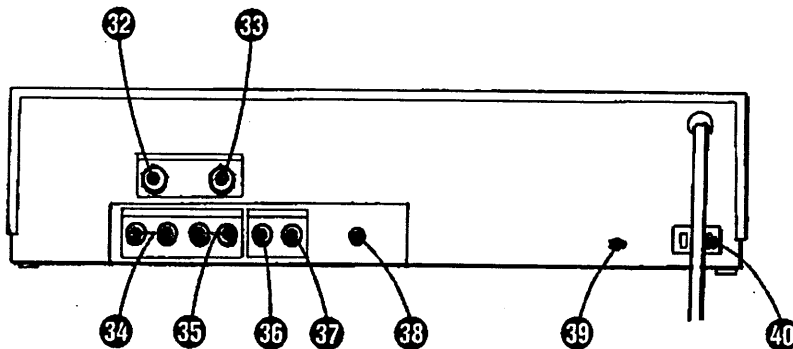

① POWER switch and Indicator

Press to turn the power on. The Indicator lights up. To turn the unit off, press the switch again. The timer section will continue to operate and the time will be displayed even if the POWER switch is off, as long as the ac power cord is plugged into a working outlet.

② EJECT button

Press this button to eject the cassette. In playback, rewind and fast-forward operations, if EJECT is pressed, tape transportation will stop and the cassette will be ejected.

③ Cassette compartment

Insert a cassette here. To eject the cassette press EJECT.

- ④ **Remote sensor**
Detects the Infrared transmitting signal from the supplied Remote Commander.
- ⑤ **Beta hi-fi Indicator**
When recording with the BETA HI-FI switch at ON, this indicator lights up. When playing back a Beta hi-fi recorded tape, the indicator lights up regardless of the BETA HI-FI selector's position.
- ⑥ **STEREO Indicator**
This indicator lights up when a stereo broadcast is received with the AUTO STEREO switch set to ON.
- ⑦ **SAP (Second Audio Program) indicator**
This indicator lights up to show that the NORMAL AUDIO selector is set to SAP.
- ⑧ **PEAK LEVEL METER**
This meter shows the peak input level of the right and left channels during Beta hi-fi recording. During playback, this meter shows the recorded level.
- ⑨ **REC LEVEL control**
Adjust the recording level when the BETA HI-FI selector is set to ON. Usually set to 5 (green position). When you record sound from other audio equipment, adjust manually to the proper position to get the optimum result.
- ⑩ **Display window**
 - Ⓐ Indicates the VTR mode.
 - Ⓑ Program position will change in numerical sequence when TIMER SET is pressed.
 - Ⓒ Lights when timer-activated recording turn-on or turn off is being set.
 - Ⓓ Time display and tape counter
 - Ⓔ The day of the week indication
 - Ⓕ Channel memory position to be selected while pre-setting channels.
 - Ⓖ Indicates recording or playback mode.
 - Ⓗ The tape speed selected is displayed.
 - Ⓘ Lights during automatic playback and automatic stop.
 - Ⓚ Channel display
 - Ⓛ While setting a timer-activated recording, TIMER will appear. When TIMER REC ON/OFF or QUICK TIMER is pressed, TIMER REC will appear.
 - Ⓜ Lights when a cassette is inside.
 - Ⓝ Lights when SET in the tuning compartment is pressed for presetting channels.
 - Ⓟ A sequence of dots show the speed and direction in which the tape is running. When a channel is being preset, the dots show the approximate location of the channel in the band.
 - Ⓡ Band indications: When a channel is being pressed, the band in which the channel is being tuned will light up.
V_L: VHF low, M: mid-band, V_{H-S}: high and super band, U: UHF
 - Ⓢ Cable TV channel is selected.
- ⑪ **Tuning compartment**
- ⑫ **NORMAL AUDIO (MAIN/SAP) selector**
Select the sound to be recorded on the conventional audio track. Normally set to MAIN. If a Multichannel TV Sound broadcast is received, the MAIN sound will be recorded. To record SAP sound, set to SAP.
- ⑬ **SET button**
Press this button to tune in a channel to be preset. The TUNING indication appears in the window. After presetting, press again to set to release.
- ⑭ **RF UNIT selector**
Select the channel for the VCR program and the output from the VHF/UHF OUT connector. Set the selector to 3 CH or 4 CH, whichever is not active in your area.
- ⑮ **AFT selector**
Normally set to ON. The automatic fine tuning circuit locks in and maintains a sharp picture. When the signal is weak on a particular channel, set to OFF.
- ⑯ **AUTO STEREO switch**
Normally set to ON. A stereo broadcast will be received in stereo. When there is excessive noise in a stereo program due to a weak incoming signal, set the selector to OFF. The noise will be reduced but the sound will become monaural.
- ⑰ **CHANNEL NO (number) buttons.**
Change the channel number displayed to match the channel received. Press "10" to change the tens digit, and "1" to change units digit.
- ⑱ **TUNING buttons**
Press to tune in an active channel. Every time you press, a channel will be tuned in. The band indication, V_L, M, V_{H-S} or U, of the band being scanned to tune in a channel light up in the window.
- ⑲ **CLEAR button**
Press to cancel the memory of a particular channel in order to skip the unused channel.
- ⑳ **CLOCK/COUNTER button**
Select the display mode, tape counter or the clock.
- ㉑ **CLEAR/RESET button**
Press the button to reset the time counter to "00 00" and also to clear the timer setting.
- ㉒ **TV/VTR button**
Press this button to view the program selected on the recorder. The VTR indication appears in the display window.
To view a different TV program than the one being recorded, press the button again so that the VTR indication disappears.
When you press ► PLAY, the VTR indication reappears.
- ㉓ **QUICK TIMER button**
Press to start the timer recording quickly. The recording time is selected in 30 minute intervals, from 0:30 to 5:00. Press this button as many times as required until the desired recording time is displayed.
- ㉔ **+/- buttons**
Press to select the channels and to set the clock or timer programs.
- ㉕ **TIMER REC ON/OFF button**
Press to activate the timer recording. To deactivate the timer recording (including quick timer recording), press again.
- ㉖ **NEXT button**
Press to advance to the next item to be set during clock or timer setting.
- ㉗ **TIMER SET button**
Press this button as the first step in setting or resetting timer recording.

- ⑳ **CHECK button**
Press to check the contents of the timer presettings.
- ㉑ **CLOCK button**
Press this button as the first step in setting the current time.
- ㉒ **ⓂII / ⓂIII selector**
This selects the recording speed, ⓂII or ⓂIII. The recording time of any given cassette in the ⓂIII mode is 1.5 times that in the ⓂII mode.
The playback speed is automatically set regardless of this selector's position.
- ㉓ **MONITOR SELECT HI-FI/NORMAL selector**
Select the sound to be played back.
HI-FI: Normally set to this position. The sound recorded on the video track in Beta hi-fi will be heard.
NORMAL: To monitor the sound recorded on the conventional audio track.
- ㉔ **MONITOR SELECT STEREO/L/R switch**
Select the channel(s) of the Beta hi-fi sound to be played back.
STEREO: Usually set to this position. The stereo sound will be heard.
L: To monitor the L channel of a stereo program.
R: To monitor the R channel of a stereo program.
- ㉕ **SHARPNESS control**
Adjusts the sharpness of the picture if necessary. Usually set the control at the center detent position.
- ㉖ **SUPER BETA switch**
Normally keep this switch ON to obtain high quality recording/playback picture.
Only if by setting this switch to "OFF", over-modulation in the playback of tapes recorded or played back on other VCRs seems to be eliminated, set this switch to "OFF".
- ㉗ **REC (record) button**
Slide to the right to start recording. The REC indication appears in the display window.
- ㉘ **Tape transport buttons**
 - ◀◀ **REW (rewind) button:** Pressing this button during playback enables you to view a high-speed playback in reverse (Betascan).
 - ▶ **PLAY button:** When ◀◀ REW is kept pressed and ▶ PLAY is pressed, the tape returns to the beginning or to the point where the tape counter indicates "0000" then automatically begins to play back. While the tape is played back, PLAY indication will appear in the window.
 - ▶▶ **FF (fast-forward) button:** Pressing this button during playback enables you to view high-speed playback (Betascan).
 - **STOP button:** Press to stop the tape running. When ◀◀ REW is kept pressed and ■ STOP is pressed, the tape returns and stops at the point where the tape counter indicates "0000". A sequence of dots will disappear.
 - || **PAUSE/▶◀ STILL button:** Press to stop the tape momentarily during recording or playback. A still picture will be seen during playback. Press again to release pause mode.
- ㉙ **MPX FILTER/PCM selector**
MPX FILTER OFF: Usually set to this position.
MPX FILTER ON: for recording FM broadcast programs (Only if your FM tuner has an internal MPX filter, set to OFF.)

PCM: for PCM recording
The setting of this switch is not necessary for TV recordings.

- ㉚ **INPUT SELECT switch**
Select the program to be recorded.
TUNER: for recording TV programs
LINE/PCM: for recording signals connected to VIDEO/PCM IN and LINE AUDIO IN.
LINE AUDIO: for recording sound from LINE AUDIO IN and picture of TV program on FM simulcast recording
- ㉛ **TRACKING control**
If streaks or snow appears in the playback of a cassette which has been recorded on another video cassette recorder, turn this knob to obtain the best possible picture. Return the control to the center position after viewing the cassette.
The center detent position provides the correct tracking for the cassettes recorded on this recorder.

Rear

- ㉜ **VHF/UHF IN connector (F-type)**
Connect the VHF and/or UHF antenna cable(s).
- ㉝ **VHF/UHF OUT connector (F-type)**
Connect to the VHF and/or UHF antenna terminal(s) of a TV receiver. The signal of a VCR program converted to channel 3 or 4 and the VHF/UHF TV signal will be supplied to the TV receiver.
- ㉞ **LINE AUDIO IN jacks (phono type)**
Connect the line output of a sound source such as a tape recorder, an amplifier, a tuner, or the audio output of another video cassette recorder.
- ㉟ **LINE AUDIO OUT jacks (phono type)**
Connect to the audio input of a color monitor, TV, another video cassette recorder, or connect to a stereo system.
- ㊱ **VIDEO/PCM IN jack (phono type)**
Connect to the video output of another video cassette recorder, camera adaptor, etc. For PCM recording, connect a PCM digital audio processor here.
- ㊲ **VIDEO/PCM OUT jack (phono type)**
Connect to the video input of a color monitor, TV or another video cassette recorder. For PCM playback, connect a PCM digital audio processor here.
- ㊳ **CONTROL S input jack (mini type)**
Connect to the CONTROL S output jack of other Sony products for various systematic operations. When this jack is connected to the CONTROL S OUT (EDIT) jack of the Sony SL-HF900 video cassette recorder, automatic assemble editing operation of the SL-HF900 can be activated with this recorder.
- ㊴ **BETA HI-FI selector**
ON: Normally, set to this position. Recording will be done in Beta hi-fi. (A tape not recorded in Beta hi-fi will be played back conventionally.)
OFF: Set to this position when recording only in the conventional (not Beta hi-fi) system.
- ㊵ **AC OUTLET**
This unswitched outlet supplies ac power to video or audio equipment with power consumption under 400 watts.

SPECIFICATIONS

System

Video recording system	Rotary two-head helical scanning
Audio recording system	Beta hi-fi system (2 channels) (Recording on the conventional audio track is monaural)
Video signal	EIA standard, NTSC color
Usable cassettes	Cassettes having the mark ⓑ ⓑIII : 1.33 cm/sec. ⓑII : 2.0 cm/sec. ⓑI : 4.0 cm/sec. (only for playback)
Maximum recording time	ⓑIII : 5 hours ⓑII : 3 hours 20 min. (with sony L-830 cassette)
Fast-forward and rewind time	Approx. 3½ min.(L-500)
Audio frequency response	Beta hi-fi OFF ⓑII : 50-10,000 Hz ⓑIII : 50-7,000 Hz Beta hi-fi MPX FILTER OFF ⓑII , ⓑIII : 20-20,000 Hz
Wow and flutter	Beta hi-fi ON Less than 0.005% WRMS
Dynamic range	Beta hi-fi ON More than 80 dB

Tuner section

Channel coverage	VHF channels 2 to 13 UHF channels 14 to 69 CATV channels 14 to 36, 98 and 99
VHF output signal	Channel 3 or 4 (selected) 75 ohms, unbalanced
Antenna	75-ohm antenna terminal for VHF and UHF

Inputs and outputs

Video input	Phono jack (1) 1 V p-p ±0.5 V p-p, 75 ohms, unbalanced, sync negative
Video output	Phono jack (1) 1 V p-p ±0.5 V p-p, 75 ohms, unbalanced, sync negative
Audio input	Phono jack (2) -10 dBs (0 dBs = 0.775 V rms), more than 47 k ohms
Audio output	Phono jack (2) -10 dBs (at load impedance 47 k ohms) more than 10 k ohms

Timer section

Clock	Synchronized with the power frequency
Time indication	12-hour cycle
Timer setting	Only to start and stop recording 6 programs can be set over 7 days

General

Power requirements	120V ac ±10%, 50/60 Hz ±0.5%
Power consumption	42 W
AC outlet	Unswitched max. 400 W
Operating temperature	5°C to 40°C (41°F to 104°F)
Storage temperature	-20°C to +60°C (-4°F to + 140°F)
Dimensions	Approx. 430 × 105 × 382 mm (w/h/d) (17 × 4¼ × 15½ inches) Incl. projecting parts and controls
Weight	Approx. 10 kg (22 lb 1 oz) net

Remote Commander RMT-124

Remote control system	Infrared control
Power requirements	3 V dc, 2 size AA batteries (IEC designation R6)
Dimensions	Approx. 43 × 18 × 175 mm (w/h/d) (1¾ × ¾ × 7 inches) Incl. projecting parts and controls
Weight	Approx. 105 g (3.7 oz) incl. batteries

Accessories supplied

75-ohm coaxial cable with F-type connectors (2 m, 6 feet).....	1
Antenna connector EAC-25	1
Connecting cord RK-74A.....	1
Remote Commander RMT-124 with two size AA batteries.....	1

Design and specifications subject to change without notice.

TROUBLE CHECKS

If any difficulty should arise during operation, first check the power cord connection, then go through the following list. Should the difficulty persist, unplug the unit and contact your Sony dealer or local authorized Sony service facility.

	Symptom	Possible causes and corrections
POWER	POWER switch does not function.	<ul style="list-style-type: none"> ● The recorder is in the timer standby mode. Press TIMER REC ON/OFF.
	The clock has stopped at "Su AM 12:00".	<ul style="list-style-type: none"> ● There has been a power interruption. Reset the clock time and timer settings.
CLOCK AND TIMER	Timer setting cannot be made.	<ul style="list-style-type: none"> ● The clock time is not set. ● The timer cannot be set during recording.
	TV program is not clearly displayed on the TV screen.	<ul style="list-style-type: none"> ● The channel for video recorder on the TV receiver is not correctly tuned. ● The TV signal is weak. Adjust the direction of the antenna. ● The ac power cord of the recorder is disconnected.
TV RECEPTION	Stereo programs are heard in monaural.	<ul style="list-style-type: none"> ● AUTO STEREO is set to OFF.
RECORDING AND PLAYBACK	No picture on the TV screen during recording or playback.	<ul style="list-style-type: none"> ● The TV's channel is not set to that preset for the video recorder.
	Picture being recorded cannot be monitored on the TV screen.	<ul style="list-style-type: none"> ● Press TV/VTR so that the VTR lights in the window.
	Noisy picture	<ul style="list-style-type: none"> ● The video heads may be contaminated. Clean the heads using the Sony L-25CL video head cleaning cassette. For details on cleaning, refer to the instructions furnished with the cleaning cassette. If the L-25CL cleaning cassette is not available in your area, have the heads cleaned at the nearest Sony service facility.
	Distorted or noisy sound	<ul style="list-style-type: none"> ● Recording level was not properly adjusted.
	Sound drop-outs of a Beta hi-fi recorded tape	<ul style="list-style-type: none"> ● The tape is defective. Use a new video cassette tape.
	Timer recording cannot be made correctly.	<ul style="list-style-type: none"> ● The clock time is not set correctly. ● There has been a power interruption. ● The cassette inserted has had the tab removed or no cassette has been inserted. ● The tape is at its tape end. ● Two or more timer settings overlap.
	SAP sound cannot be recorded.	<ul style="list-style-type: none"> ● Set NORMAL AUDIO to SAP. To listen to the SAP, set the MONITOR SELECT (HI-FI/NORMAL) to NORMAL.
	No sound was recorded in the conventional audio track.	<ul style="list-style-type: none"> ● NORMAL AUDIO was set to SAP and there was no SAP broadcast.
	SAP sound cannot be played back.	<ul style="list-style-type: none"> ● Set MONITOR SELECT HI-FI/NORMAL to NORMAL.
	No sound is heard during playback.	<ul style="list-style-type: none"> ● A tape on which no sound is recorded on the conventional audio track is being played back with MONITOR SELECT HI-FI/NORMAL set to NORMAL. Set the switch to HI-FI.
OTHERS	The tape counter does not operate even if the tape moves.	<ul style="list-style-type: none"> ● The tape is brand-new. ● It will not operate with the unrecorded portion of a tape.
	Cassette cannot be inserted.	<ul style="list-style-type: none"> ● The cassette being inserted is reversed. ● Another cassette has already been inserted.
	The cassette cannot be ejected.	<ul style="list-style-type: none"> ● The recorder is turned off. ● Recording is being done.
	The tape stops suddenly during operation.	<ul style="list-style-type: none"> ● The safety device which protects the video cassette tape and recorder has activated. Reactivate the previous tape transport mode.
	The function buttons cannot be activated immediately after the cassette has been inserted into the recorder.	<ul style="list-style-type: none"> ● The safety device has activated. Press EJECT to remove the cassette and re-insert the cassette.

TIMER SETTING GUIDE

Check before setting

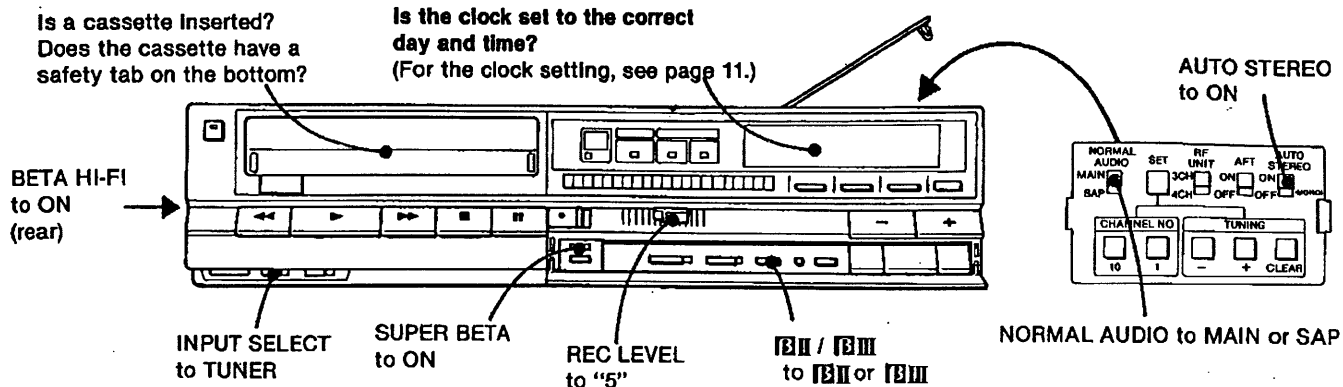

Set the timer

